

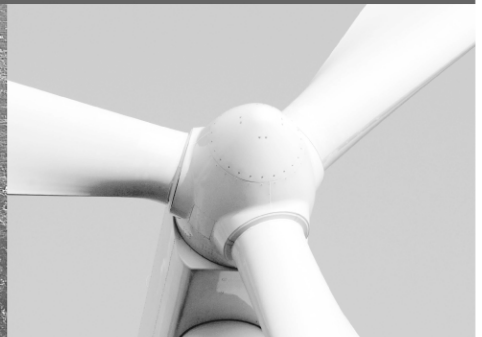

-power in control



INSTALLATION INSTRUCTIONS



Delomatic 400, DM-400



DEIF A/S · Frisenborgvej 33 · DK-7800 Skive
Tel.: +45 9614 9614 · Fax: +45 9614 9615
info@deif.com · www.deif.com

Document no.: 4189340881B
SW version 1.3X.X or later

Table of contents

1. ABOUT THIS DOCUMENT	3
GENERAL PURPOSE.....	3
INTENDED USERS	3
CONTENTS/OVERALL STRUCTURE	3
2. WARNINGS AND LEGAL INFORMATION	4
LEGAL INFORMATION AND RESPONSIBILITY	4
ELECTROSTATIC DISCHARGE AWARENESS.....	4
SAFETY ISSUES.....	4
DEFINITIONS	4
3. GENERAL OVERVIEW	5
4. COMPONENTS	6
19" RACK.....	6
PCM 4.3 MODULE	8
SCM 4.1 MODULE	11
IOM 4.2 MODULE	14

1. About this document

General purpose

This document contains the installation instructions for DEIF's Delomatic 400, DM-400 Gas/Hydro plant controller for gas engine/hydro turbine-driven generators.

The general purpose is to give the designer/installer important information on how to perform a proper installation.



Please make sure to read this handbook before working with the DM-400 controller and the genset to be controlled. Failure to do this could result in damage to the equipment or human injury.

Intended users

This document is mainly intended for the designer/installer.

Contents/overall structure

The document is divided into chapters, and in order to make the structure simple and easy to use, each chapter will begin from the top of a new page.

2. Warnings and legal information

Legal information and responsibility

DEIF takes no responsibility for installation or operation of the generator set. If there is any doubt about how to install or operate the generator set controlled by the unit, the company responsible for the installation or the operation of the set must be contacted.

In order to obtain safe and trouble-free use of the DM-400, it is important that transport, storage, mounting and commissioning is done according to standards.

The units are not to be opened by unauthorised personnel. If opened anyway, the warranty will be lost.

Electrostatic discharge awareness

Sufficient care must be taken to protect the terminals against static discharges during the installation. Once the unit is installed and connected, these precautions are no longer necessary.

Safety issues

Installing the unit implies work with dangerous currents and voltages. Therefore, the installation should only be carried out by authorised personnel who understand the risks involved in working with live electrical equipment.



Be aware of the hazardous live currents and voltages. Do not touch any AC measurement inputs as this could lead to injury or death.

Extra care must be taken that components are not replaced with power on the system.

Definitions

Throughout this document, a number of notes and warnings will be presented. To ensure that these are noticed, they will be highlighted in order to separate them from the general text.

Notes



The notes provide general information which will be helpful for the reader to bear in mind.

Warnings



The warnings indicate a potentially dangerous situation which could result in death, personal injury or damaged equipment, if certain guidelines are not followed.

3. General overview

As a minimum, the DM-400 system consists of a double-height (6 HE, 266 mm height) 19" rack mounted with the necessary I/O modules and a 12" colour graphic touch screen operator interface.

The DM-400 has a TCP/IP interface with a built-in webserver. This means that the graphic screens are stored here and can be accessed from any computer on the internet, using a free of charge DEIF HMI Client software and thereby enabling remote control and monitoring from anywhere in the world.

Connecting an RS232 GSM modem enables SMS clear text alarm messages.

4. Components

The DM-4 system consists of three different plug-in modules, placed in a 19" rack. Each module holds its own microprocessor and operates independently of the other modules. The modules communicate with each other using the 19" rack backplane.

Each rack holds as a minimum:

- 1 pc. PCM 4.3 (Power supply and Control Module)
- 1 pc. SCM 4.1 (Synchronising and Control Module)
- 1 pc. IOM 4.2 (Input Output Module)

19" rack

The rack depth is 180 mm.

24 TE for 2 modules

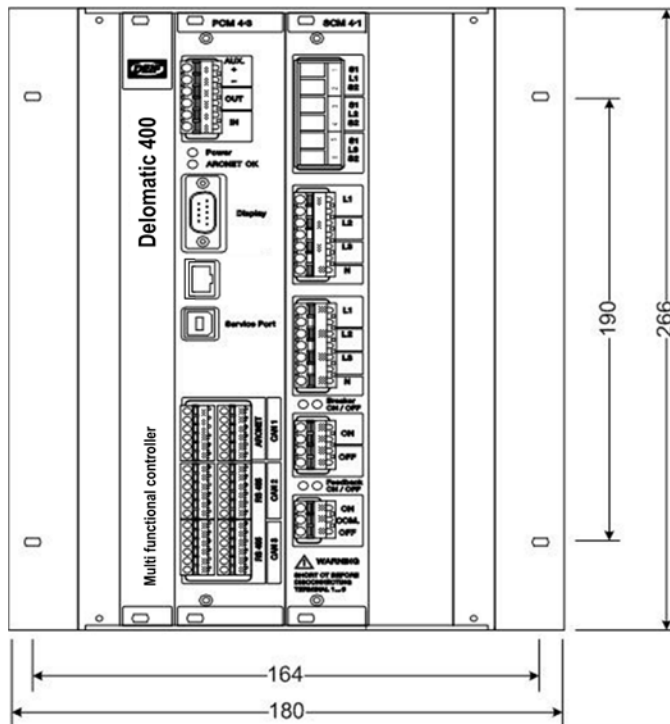

42 TE for 3 to 6 modules

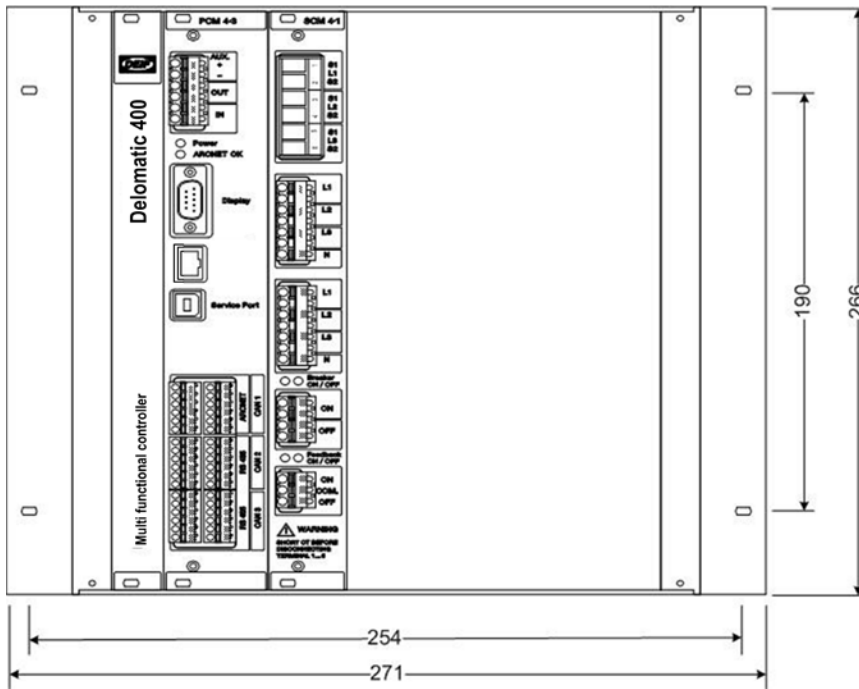

60 TE for 6 to 8 modules

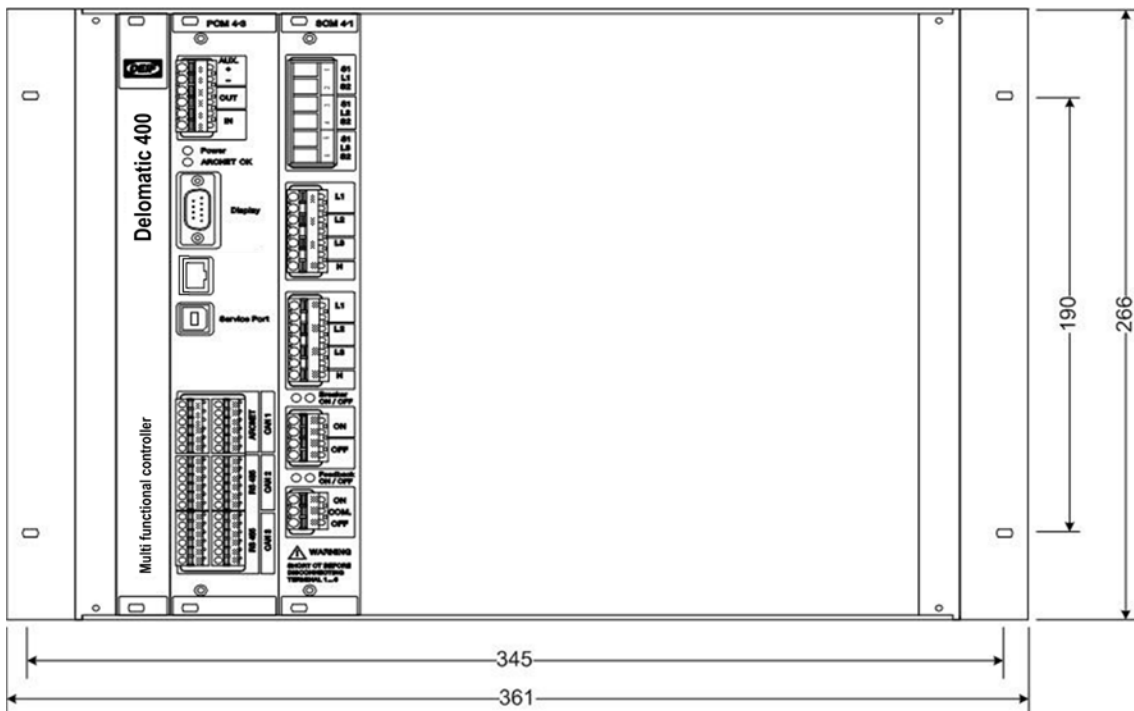

PCM 4.3 module

General

The PCM 4.3 is at the same time power supply and main control module for the DM-400 system. It is placed leftmost in the rack and provides power as well as data exchange between the modules via the backplane. Furthermore, it holds the main control programme (application software), meaning that it controls the common functionality for the plant.

Height: 8TE

Power supply

The Delomatic 400 requires 24 V DC (nominal) power supply. Please refer to the data sheet for exact voltage range and power consumption.



If the system is to comply with IEC60255-11 for surviving power supply dips, a system with a battery charger and a 24 V DC battery backup is needed to maintain supply voltage. The size of battery is dependent on what other loads are connected, but as a rule-of-thumb, the battery must be at least 24 V DC, 10 AH.

Communications

CANbuses:	3
CANbus speed:	125...1000 kBaud
RS485 interface:	1
RS485 speed:	9600...38400 Baud
ARC net interface:	1
ARC net speed:	2.5 MBaud
Ethernet interface:	1
Ethernet speed:	10/100 MBaud
Modem interface:	1
Modem interface type:	TTL
Modem interface speed:	9600...38400 Baud

The modem interface is used for GSM modem connection via a TTL/RS232 converter (DEIF PI-1 converter).



The 9-p SUB-D connector for the modem is named “Display” on the module front.

The cabling of the CAN/RS485/ARC net communication interfaces must be carried out with a good quality screened twisted pair cable.

Make sure that the cable screen covers as much of the cable as possible and is terminated with tape or heat shrink tubes.



It is essential that the “screen” terminals are used for the cable screen and that cable screen is connected to DEIF units only. Connecting it to ground or 3rd party units may cause the communication to fail.

Hardware layout

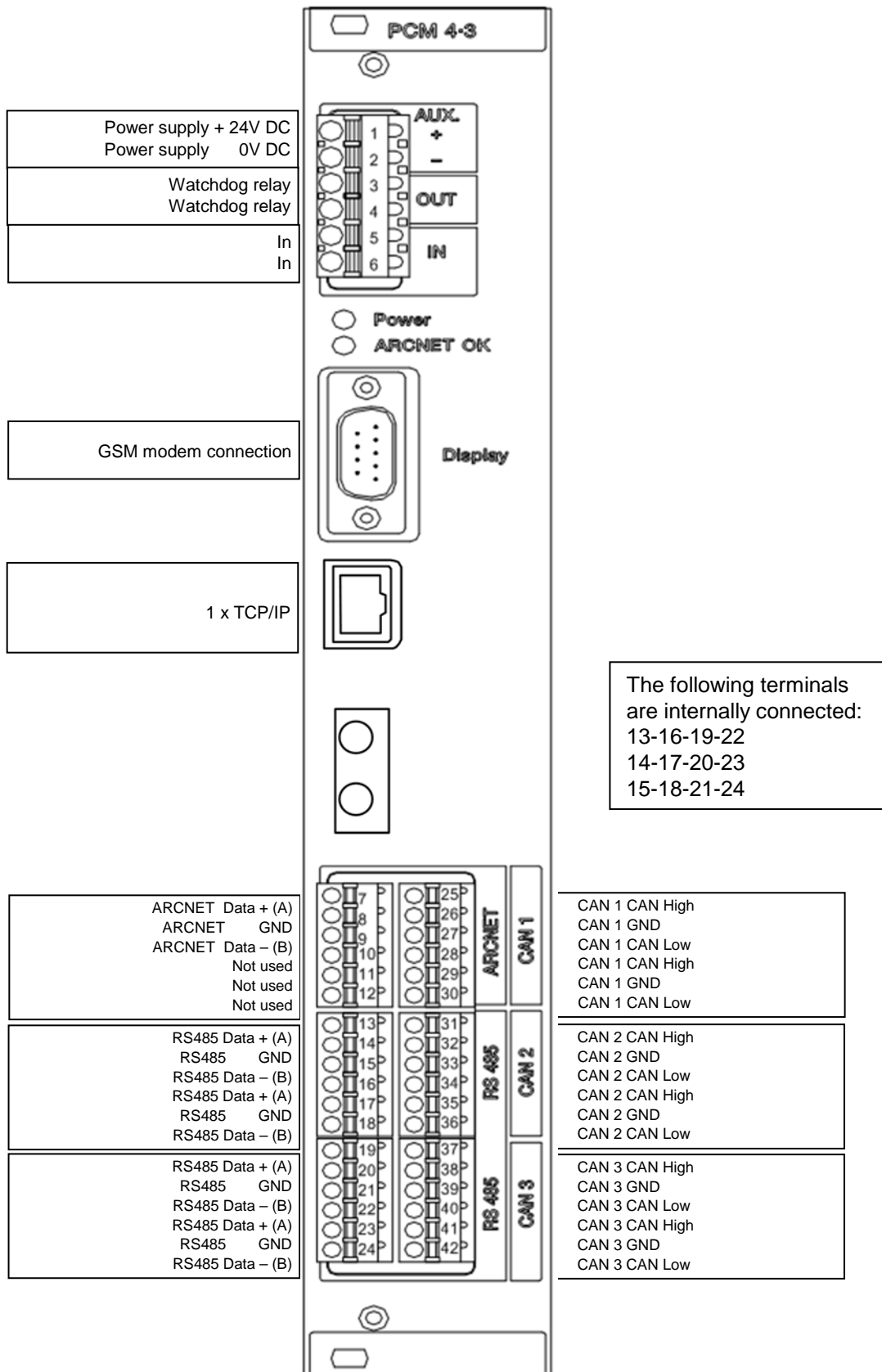

CAN bus connection between units

The CAN bus connection between Delomatic 400 units are used for load sharing/power management.

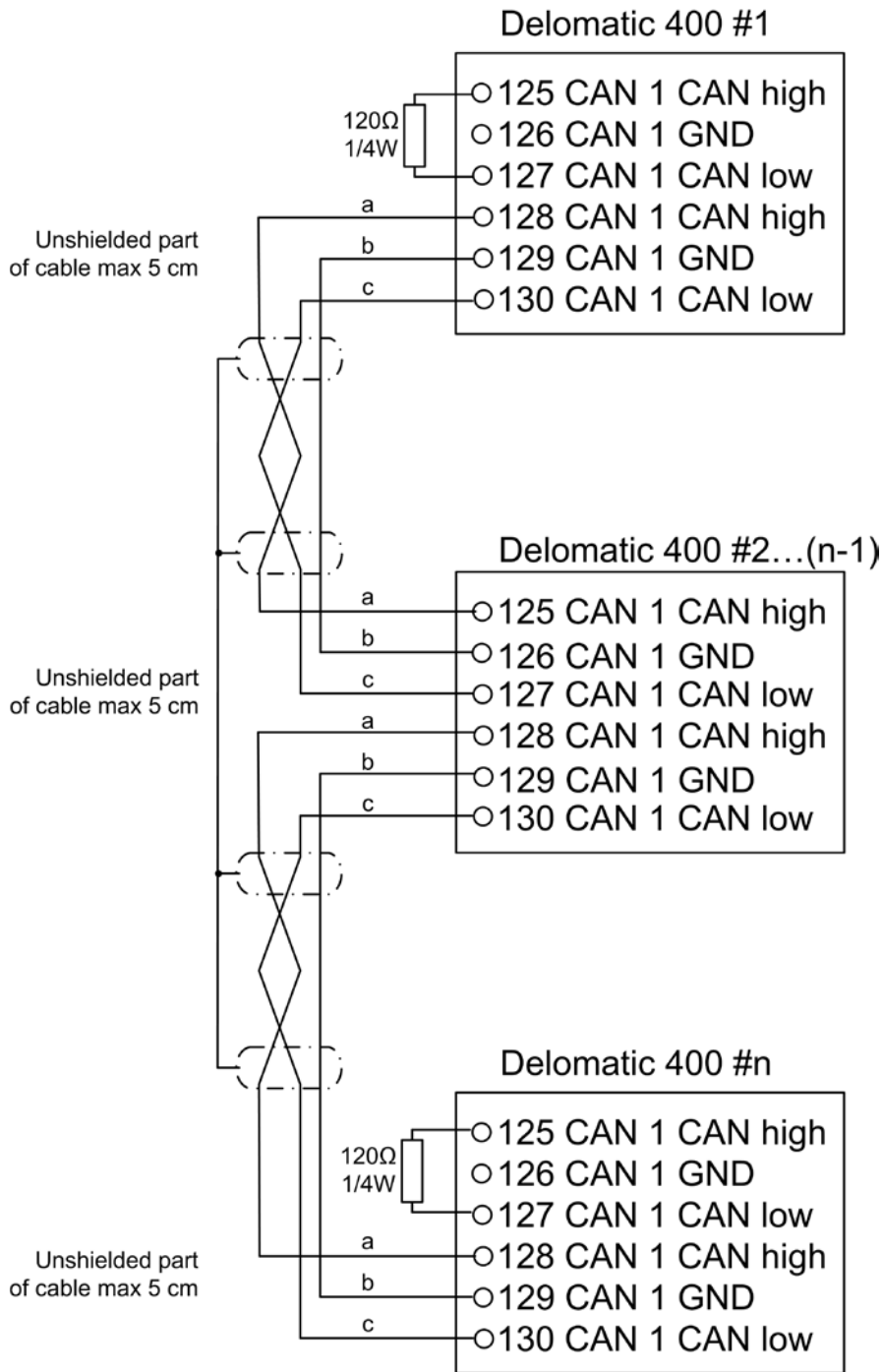

Minimum cable length between units: 2 m.

Cable: Use CAN bus cable, screened, twisted wires, 0.34-1.0 mm²

SCM 4.1 module

The SCM 4.1 module is the AC measuring module of the system. Furthermore, it holds the fast AC protections of the system.

AC voltage:	100...690 V AC
AC current:	1 or 5 A from current transformer
Frequency range:	40...70 Hz
Generator measurements:	3 x voltage + N, 3 x current
Busbar/mains measurements:	3 x voltage + N
Accuracy:	Class 0.5

AC measurements

With one SCM 4.1 module

- Generator voltages U_{gen}
- Generator currents I_{gen}
- Mains voltages U_{mains}
- Generator power P_{gen}
- Generator reactive power Q_{gen}
- Generator apparent power S_{gen}
- Generator Cos Phi
- Generator frequency f_{gen}
- Mains frequency f_{mains}
- Phase angle

With two SCM 4.1 modules

- Generator voltages U_{gen}
- Generator currents I_{gen}
- Busbar voltages U_{mains}
- Generator power P_{gen}
- Generator reactive power Q_{gen}
- Generator apparent power S_{gen}
- Generator Cos Phi
- Generator frequency f_{gen}
- Mains power P_{mains}
- Mains reactive power Q_{mains}
- Mains apparent power S_{mains}
- Mains Cos Phi
- Mains frequency f_{mains}
- Phase angle

The measured AC values are transmitted to the PCM 4.3 module once per period.

Hardware layout

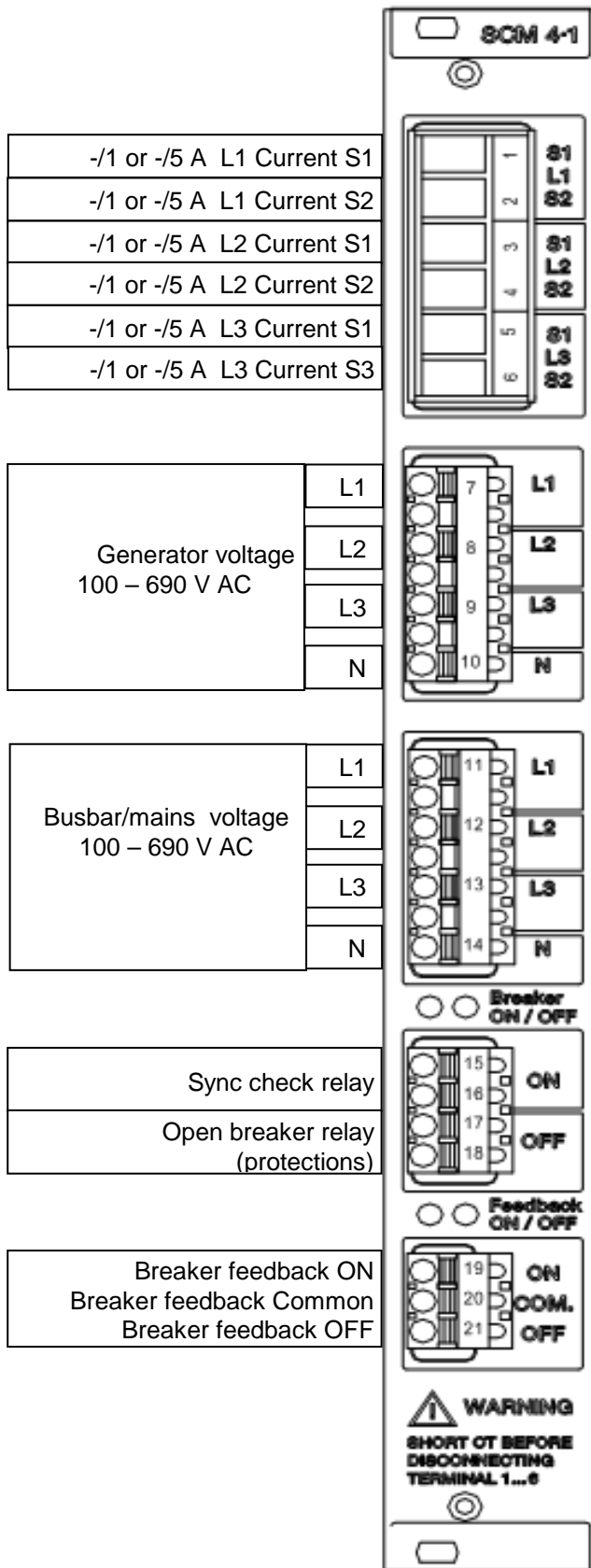

AC inputs layout

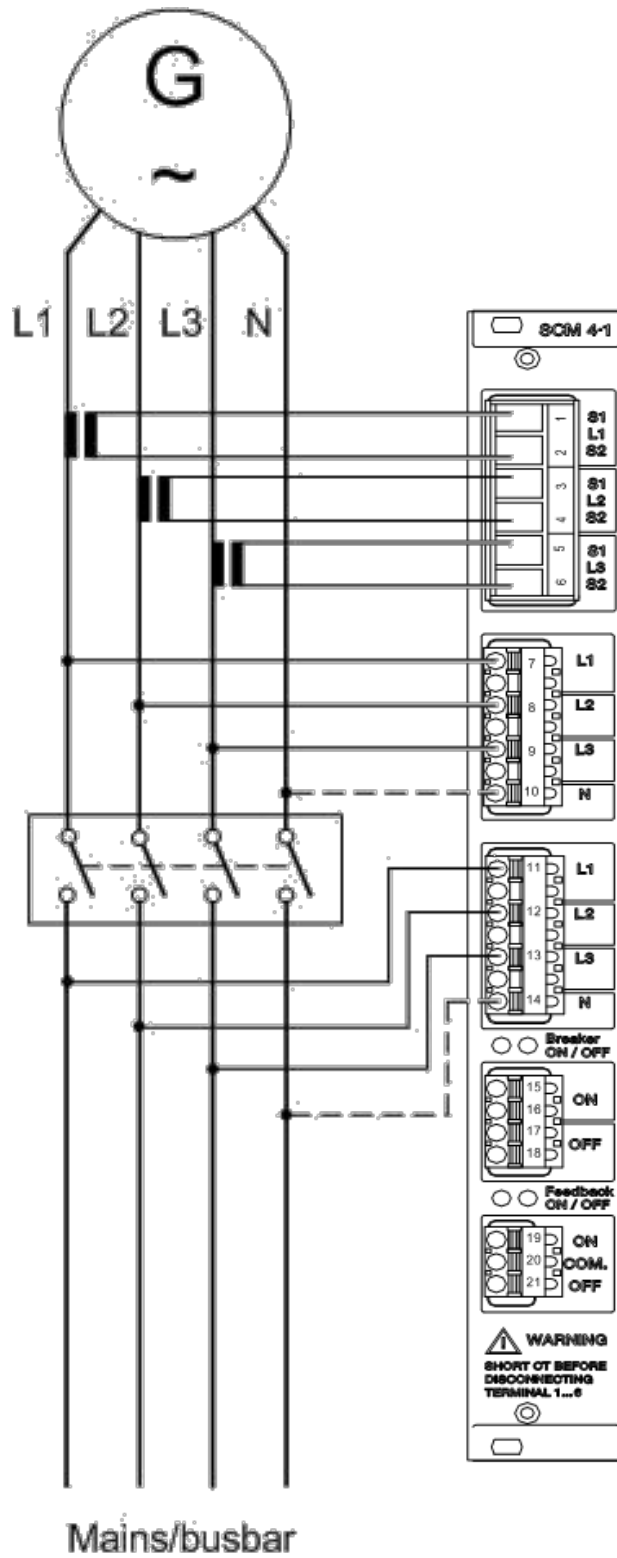

IOM 4.2 module

The IOM 4.2 module is a multifunctional interface to different sensors and can be used as interface to other systems via digital and analogue signals.

6	Pt100 or Pt1000 inputs	2-, 3- or 4-wire configuration
6	NiCrNi (type K) inputs	Alternative to the 6 Pt100/Pt1000 inputs
4	Analogue mA inputs	12 bit
4	Analogue +/- 20 mA outputs	10 bit. Burden 500 Ω max.
12	Digital inputs	Voltage: 9...36 V DC positive or negative logic, common + or -
4	RPM/digital inputs	Voltage: 2...36 V DC Individually, galvanically separated Max. 20 kHz
10	Digital outputs	9...36 V DC using external power supply Max. 200 mA load Short-circuit-protected Protected against thermal overload

Galvanic separation Between analogue inputs/analogue outputs/digital inputs/digital outputs.
To backplane (internal loops over the different modules are not possible).



It is important that the connections are made correctly. In case of wrong wiring the hardware can be damaged.



The letter marking of the connections below refers to the drawing of the module

NiCrNi inputs:

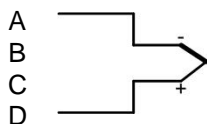

Pt100/Pt1000 inputs:

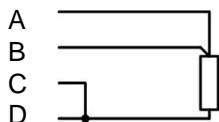

4-20 mA inputs:

2-wire

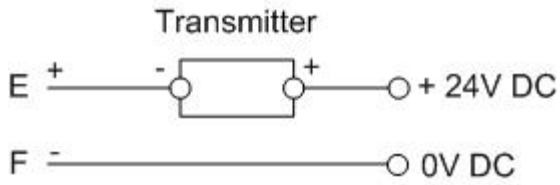

3-wire

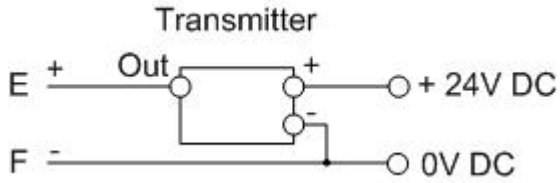

0-10V DC inputs:

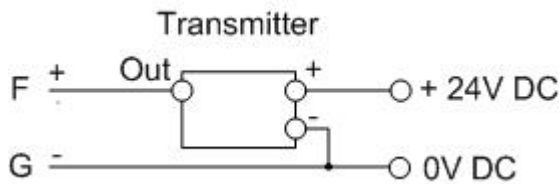

+/- 20 mA outputs:

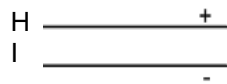

Digital inputs:

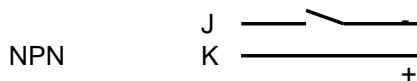
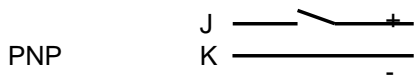

Pickup/Digital inputs:

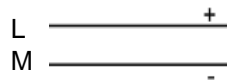

Pickups with push-pull transistor outputs are preferable.

Transistor outputs:

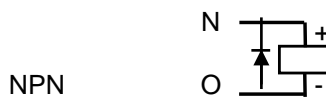
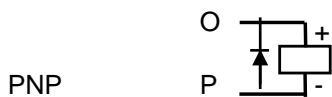

Hardware layout

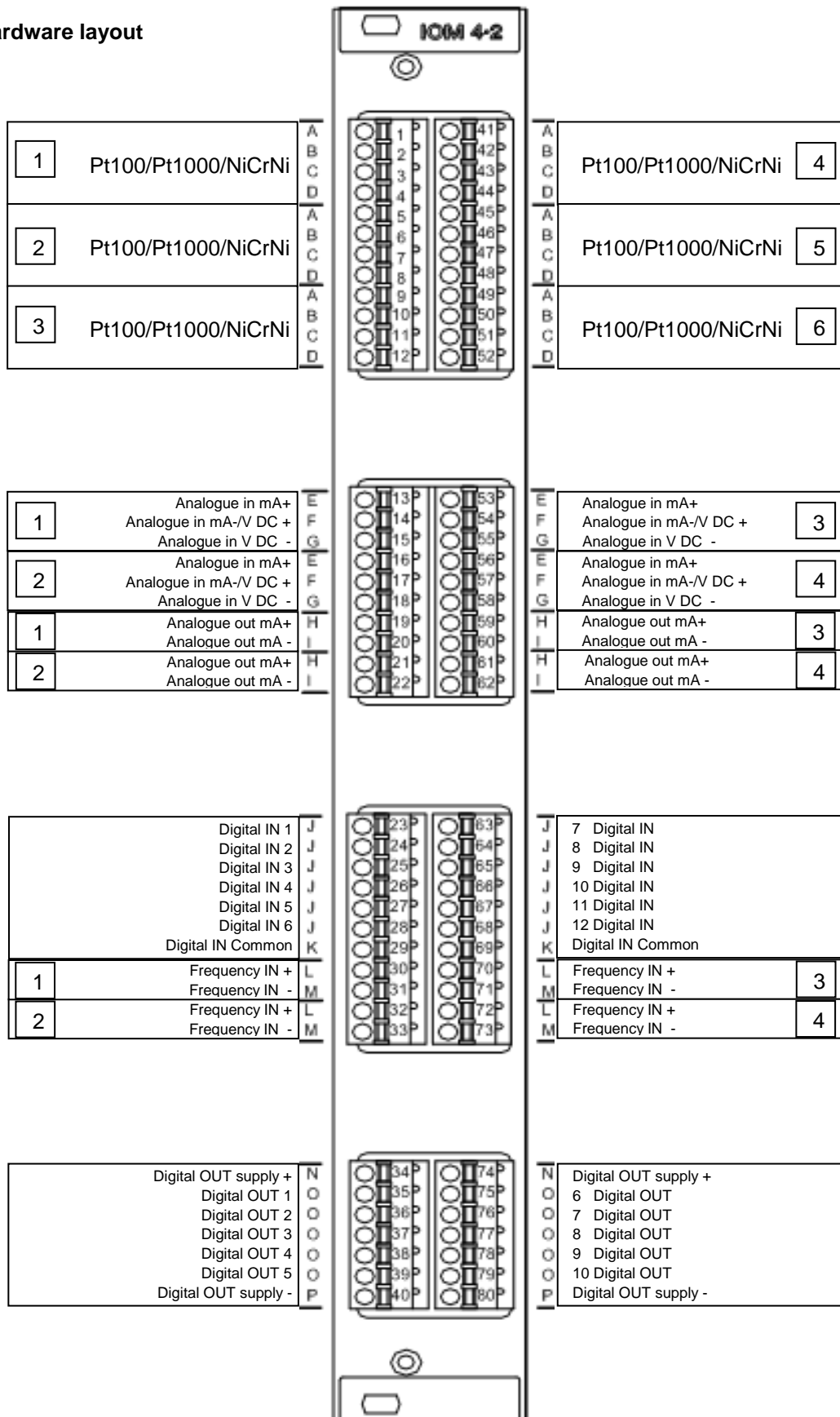

DEIF A/S reserves the right to change any of the above.