

Transducers for AC measurement

Types TAP, TAQ, TMF, TAA, TAV, TAC

4921220002E

REPLACEMENT

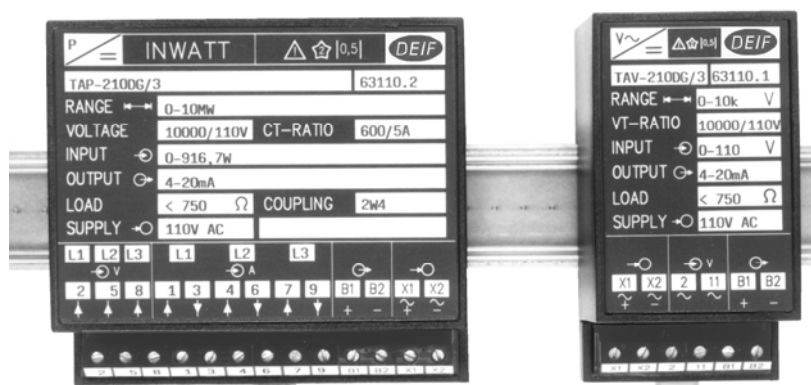

- **Measurement of:**
watt, var, frequency, phase angle, voltage, current
- **Accuracy class 0.5**
- **For mounting on DIN rail**
- **Compact design**
- **Aux. voltage: 57.7...440V AC or 24...220V DC**
- **According to IEC 688**

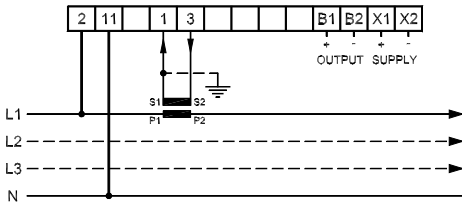
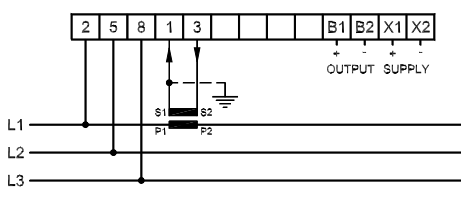
Transducer type	 Watt	
Type	TAP-210DG/3. 1W	TAP-210DG/3, 1W3
Measuring	Single phase network	3-Phase 3 wire network Balanced load
Connection diagrams for DEIF transducers for DIN rail mounting Numbering of terminals according to DIN 43807		
Measuring principle	Time-Division-Multiplication (TDM) RMS measurement	
Measuring voltage (U_{nom})	57.7..440V AC $\pm 20\%$ (0..120% U_{nom} with separate U_{aux}). ($\leq 0.5VA$ per phase)	
Measuring current (I_{nom})	0.5..10A AC. Measuring range: 0..120% I_{nom} ($\leq 0.3VA$ per phase)	
Measuring range	0.. P_{nom} / - P_{nom} ..0..+ P_{nom}	
Measuring frequency	45..65Hz (300..500Hz)	
Overloads Voltages	1.2 x U_{nom} , cont. / 2 x U_{nom} for 10 s	
Overloads Currents	2 x I_{nom} , cont. / 10 x I_{nom} for 10 s (max. 75A) / 40 x I_{nom} for 1 sec (max. 300A)	
Output (0..100%)	0..1mA, 0..5mA, 0..10mA, 0..20mA, 0..1V, 0..10V	
Output (20..100%)	0.2..1mA, 1..5mA, 2..10mA, 4..20mA, 0.2..1V, 2..10V	
Output (-100%..0..+100%)	-1..0..+1mA, -5..0..+5mA, -10..0..+10mA, -20..0..+20mA, -1..0..+1V, -10..0..+10V	
Output loads	Current Output: max. 15V, voltage Output: max. 20mA	
Accuracy	Class 0.5 (-10..15..30..55°C) according to IEC 688	
Response time/ripple	<150 ms / 1% _{pp} according to IEC 688	
$\Delta_{out} / \Delta U_{aux} / \Delta f_{aux} / \Delta R_{load}$	Max. 0.1%/ $\Delta 10\%$ U_{aux} / 0.1%/45..65Hz / 0.1%/ ΔR_{load} -max.	
Temperature coefficient	Typically 0.15% per 10°C. Max. 0.2% per 10°C	
Ambient temperature	-10..+55°C (nominal). -25..+70°C (operating). -40..+70°C (storage)	
Auxiliary supply (U_{aux}) (45..65Hz)	57.7 - 63.5 - 100 - 110 - 120 - 127 - 220 - 230 - 240 - 380 - 415 - 440V AC $\pm 20\%$ (3.5VA)	
Test voltage	2000V - 50Hz - 1 min.	
EMC	According to EN 50081-1/2, EN 50082-1/2, SS4361503 (PL4), IEC 255-4 (class 3). CE marked	
Climate	Class HSE, according to DIN 40040	
Protection	Case: IP52. Terminals: IP20. According to IEC 529 and EN 60529	
Terminals	Screw Terminals. Multi-stranded: 2.5 mm ² / single-stranded: 4.0 mm ²	
Case type See rear page	1	1

Order specifications

Type	TAP-210DG/3 INWATT	TAP-210DG/3 INWATT
Connection (See drawing)	1W	1W3
Measuring range	x	x
Current transformer ($I_{pri} : I_{sec}$)	x	x
Measuring voltage (U_{nom})	x	x
Voltage transformer ($U_{pri} : U_{sec}$)	x	x
Auxiliary voltage (U_{aux})	x	x
Output signal	x	x

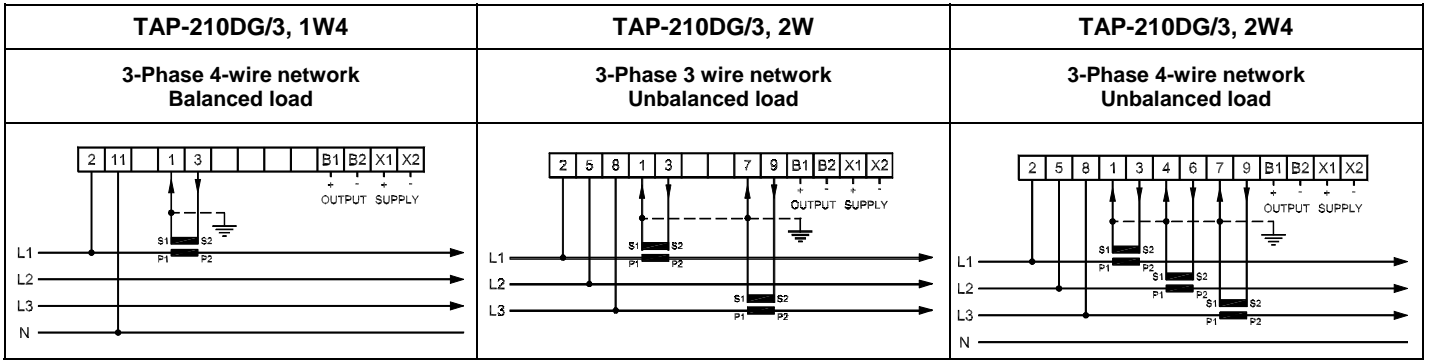

24 - 48 - 110 - 220V DC -25/+30% ($\leq 2.5W$)

for residential, commercial and light industry plus industrial environment

1	1	1
---	---	---

TAP-210DG/3 INWATT	TAP-210DG/3 INWATT	TAP-210DG/3 INWATT
1W4	2W	2W4
x	x	x
x	x	x
x	x	x
x	x	x
x	x	x
x	x	x

See rear page for calculation of measuring range for watt/var transducers

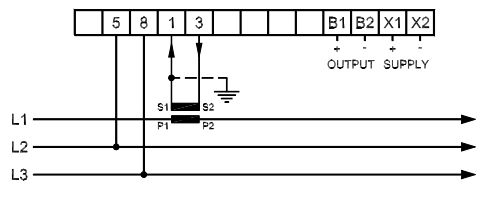
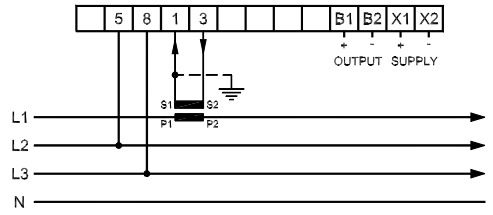
Transducer type	 Var	
Type	TAQ-210DG/3, 1VAR3	TAQ-210DG/3, 1VAR4
Measuring	3-Phase 3-wire network Balanced load	3-Phase 4-wire network Balanced load
Connection diagrams for DEIF transducers for DIN rail mounting Numbering of terminals according to DIN 43807		
Measuring principle	Time-Division-Multiplication (TDM) RMS measurement	
Measuring voltage (U_{nom})	57.7..440V AC $\pm 20\%$ (0..120% U_{nom} with separate U_{aux}), ($\leq 0.5VA$ per phase)	
Measuring current (I_{nom})	0.5..10A AC. Measuring range: 0..120% I_{nom} ($\leq 0.3VA$ per phase)	
Measuring range	0.. Q_{nom} / - Q_{nom} ..0..+ Q_{nom}	
Measuring frequency	45..65Hz (300..500Hz)	
Overloads Voltages	1.2 x U_{nom} , cont. / 2 x U_{nom} for 10 s	
Overloads Currents	2 x I_{nom} , cont. / 10 x I_{nom} for 10 s (max. 75A) / 40 x I_{nom} for 1 sec (max. 300A)	
Output (0..100%)	0..1mA, 0..5mA, 0..10mA, 0..20mA, 0..1V, 0..10V	
Output (20..100%)	0.2..1mA, 1..5mA, 2..10mA, 4..20mA, 0.2..1V, 2..10V	
Output (-100%..0..+100%)	-1..0..+1mA, -5..0..+5mA, -10..0..+10mA, -20..0..+20mA, -1..0..+1V, -10..0..+10V	
Output loads	Current Output: max. 15V, voltage Output: max. 20mA	
Accuracy	Class 0.5 (-10..15..30..55°C) according to IEC 688	
Response time/ripple	<150 ms / 1% _{pp} according to IEC 688	
$\Delta_{out} / \Delta U_{aux} / \Delta f_{aux} / \Delta R_{load}$	Max. 0.1% / $\Delta 10\%$ U_{aux} / 0.1%/45..65Hz / 0.1% / ΔR_{load} -max.	
Temperature coefficient	Typically 0.15% per 10°C. Max. 0.2% per 10°C	
Ambient temperature	-10..+55°C (nominal). -25..+70°C (operating). -40..+70°C (storage)	
Auxiliary supply (U_{aux}) (45..65Hz)	57.7 - 63.5 - 100 - 110 - 120 - 127 - 220 - 230 - 240 - 380 - 415 - 440V AC $\pm 20\%$ ($\leq 3.5VA$)	
Test voltage	2000V - 50Hz - 1 min.	
EMC	According to EN 50081-1/2, EN 50082-1/2, SS4361503 (PL4), IEC 255-4 (class 3). CE marked	
Climate	Class HSE, according to DIN 40040	
Protection	Case: IP52. Terminals: IP20. According to IEC 529 and EN 60529	
Terminals	Screw Terminals. Multi-stranded: 2.5 mm ² / single-stranded: 4.0 mm ²	
Case type See rear page	1	1

Order specifications

Type	TAQ-210DG/3 INWATT	TAQ-210DG/3 INWATT
Connection (See drawing)	1VAR3	1VAR4
Measuring range	x	x
Current transformer ($I_{pri} : I_{sec}$)	x	x
Measuring voltage (U_{nom})	x	x
Voltage transformer ($U_{pri} : U_{sec}$)	x	x
Auxiliary voltage (U_{aux})	x	x
Output signal	x	x



Frequency

<p>TAQ-210DG/3, 2VAR</p>	<p>TAQ-210DG/3, 2VAR4</p>	<p>TMF-210DG/2</p>
<p>3-Phase 3-wire network Unbalanced load</p>	<p>3-Phase 4-wire network Unbalanced load</p>	<p>Mains frequency</p>
		<p>Crystal controlled one-shot</p>
		<p>57.7..440V AC $\pm 20\%$ ($\leq 0.5VA$)</p>
		<p>_____</p>
		<p>$f_{nom} \pm 3Hz, \pm 5Hz, \pm 10Hz$</p>
		<p>$f_{nom} 50Hz, 55Hz, 60Hz$</p>
		<p>_____</p>

	<p>Class 0.2 of f_{max}.</p>
	<p>350 ms / 0.5%_{pp}</p>

Typ. 0.05% per 10°C, max. 0.1% per 10°C

24 - 48 - 110 - 220V DC -25/+30% ($\leq 2.5W$) ($\leq 2VA/2W$)

for residential, commercial and light industry plus industrial environment

1	1	1
---	---	---

TAQ-210DG/3 INWATT	TAQ-210G/3 INWATT	TMF-210DG/2
2VAR	2VAR4	
x	x	x
x	x	
x	x	x
x	x	x
x	x	x
x	x	x

See rear page for calculation of measuring range for watt/var transducers

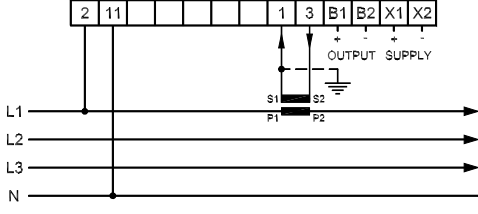
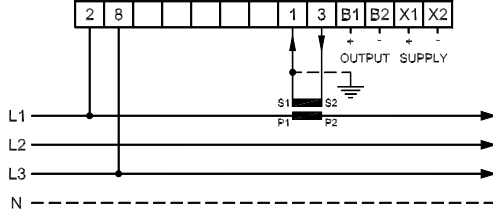
Transducer type	 Phase angle	
Type	TAA-210DG/2, WC1	TAA-210DG/2, WC3
Measuring	3-Phase network 4-wire	3-Phase network 3- or 4-wire
Connection diagrams for DEIF transducers for DIN rail mounting Numbering of terminals according to DIN 43807		
Measuring principle	Zero crossing detection. NOTE: Output proportional to phase angle (φ)	
Measuring voltage (U_{nom})	57.7..440V AC $\pm 20\%$ ($\leq 0.5VA$)	
Measuring current (I_{nom})	-1A - /-5A. Measuring range: 20..120% I_{nom} (class 0.5) 5..20% (class 1) ($\leq 0.3VA$)	
Measuring range	0.5 cap...1..0.5 ind. / 0.7 cap...1..0.3 ind. / 0..1 cap. / 0..1 ind.	
Measuring frequency	45..65Hz (300..500Hz)	
Overloads	Voltages	1.2 x U_{nom} , cont. / 2 x U_{nom} for 10 s
Overloads	Currents	2 x I_{nom} , cont. / 10 x I_{nom} for 10 s (max. 75A) / 40 x I_{nom} for 1 sec (max. 300A)
Output (0..100%)	0..1mA, 0..5mA, 0..10mA, 0..20mA, 0..1V, 0..10V	
Output (20..100%)	0.2..1mA, 1..5mA, 2..10mA, 4..20mA, 0.2..1V, 2..10V. With separate aux. voltage	
Output (-100%..0..+100%)	-1..0..+1mA, -5..0..+5mA, -10..0..+10mA, -20..0..+20mA, -1..0..+1V, -10..0..+10V	
Output loads	Current Output: max. 15V, voltage Output: max. 20mA	
Accuracy	Class 0.5 (-10..15..30..55°C) according to IEC 688	
Response time/ripple	<300 ms / 1% _{pp} according to IEC 688	
$\Delta_{out} / \Delta U_{aux} / \Delta f_{aux} / \Delta R_{load}$	Max. 0.1% / $\Delta 10\%$ U_{aux} / 0.1%/45..65Hz / 0.1% / ΔR_{load} -max.	
Temperature coefficient	Typically 0.15% per 10°C. Max. 0.2% per 10°C	
Ambient temperature	-10..+55°C (nominal). -25..+70°C (operating). -40..+70°C (storage)	
Auxiliary supply (U_{aux}) (45..65Hz)	57.7 - 63.5 - 100 - 110 - 120 - 127 - 220 - 230 - 240 - 380 - 415 - 440V AC $\pm 20\%$ ($\leq 2VA$)	
Test voltage	2000V - 50Hz - 1 min.	
EMC	According to EN 50081-1/2, EN 50082-1/2, SS4361503 (PL4), IEC 255-4 (class 3). CE marked	
Climate	Class HSE, according to DIN 40040	
Protection	Case: IP52. Terminals: IP20. According to IEC 529 and EN 60529	
Terminals	Screw Terminals. Multi-stranded: 2.5 mm ² / single-stranded: 4.0 mm ²	
Case type	See rear page	1

Order specifications

Type	TAA-210DG/2	TAA-210DG/2
Connection (See drawing)	WC1	WC3
Measuring range	x	x
Current transformer ($I_{pri} : I_{sec}$)	x	x
Measuring Voltage (U_{nom})	x	x
Voltage transformer ($U_{pri} : U_{sec}$)	x	x
Auxiliary voltage (U_{aux})	x	x
Output signal	x	x



Voltage



Current

TAV-210DG/3	TAV-220DG/3	TAC-210DG/3	TAC-220DG/3	TAC-230DG/2
AC voltage With aux. supply No sep. aux. supply		AC current With aux. supply No aux. supply 2-wire transducer		
Average measurement				
57.7..440V AC (0.5VA)	57.7..440V AC (4.5VA)			
		0.5..10A (≤ 0.3VA)	-1A & -5A (≤ 2VA)	
80..120%/0..120% U _{nom}	0...30..120% U _{nom}	0..100% I _{nom}	0..100% I _{nom} (standard) or 0..120% I _{nom}	

		As TAA-210DG	1.5 x I _{nom} cont./10 x I _{nom} - 5 s/40 x I _{nom} - 1sec	
	0..25..100%	As TAA-210DG	0..5mA/10mA/20mA	
		As TAA-210DG		4..20mA
			Max. 15V	U _{supply} - 10V
<500 ms / 1% _{RMS}	<200 ms / 1% _{RMS}		<300 ms / 1% _{pp} - IEC 688	
			≤1% Δout/ ΔR _{load} -max.	As TAA-210DG

24-48-110-220VDC -25/+30%(≤2W)	To terminals 2 - 11	As TAA-210DG	NONE	U _{supply} = 12..30V DC
---------------------------------	---------------------	--------------	------	----------------------------------

for residential, commercial and light industry plus industrial environment

2	2	2	2	2
---	---	---	---	---

TAV-210DG/3	TAV-220DG/3	TAC-210DG/3	TAC-220DG/3	TAC-230DG/2
X	X	X	X	X
		X	X	X
X	X			
X		X		
X	X	X	X	

Calculation of measuring range for watt/var transducers

U = Nominal mains voltage. 3-phase network: Between 2 phases (e.g. 3 x 10kV).
 Single phase network: Between phase and neutral.

I = Primary rated current (rated value, e.g. 500/1).

	Lowest measuring range	Highest measuring range
3-Phase network	$0.5 \times \sqrt{3} \times U \times I$	$2 \times \sqrt{3} \times U \times I$
Single phase network	$0.5 \times U \times I$	$2 \times U \times I$

Standard measuring ranges: 1 - 1.2 - 1.5 - 2 - 2.5 - 3 - 4 - 5 - 6 - 7.5 - 8 and multiples of 10 and 100 thereof.

Example

3-phase network, balanced load:	3 x 10kV	
Voltage transformer:	10k/100	
Current transformer:	500/1A	
Lowest Measuring range:	$W = 0.5 \times \sqrt{3} \times 10.000 \times 500 = 4.3\text{MW}$	Nearest higher standard range: 5.0MW
Highest Measuring range:	$W = 2 \times \sqrt{3} \times 10.000 \times 500 = 17.3\text{MW}$	Nearest lower standard range: 15.0MW
Possible ranges:	5 - 6 - 7.5 - 8 - 10 - 12 - 15MW. Could be chosen according to calculated current consumption, power factor and a suitable deflection or output.	

Note: The Measuring range of a VAR transducer should be $\geq 50\%$ of the selected measuring range of the corresponding WATT transducer, e.g. WATT transducer: -12...0...12MW, VAR transducer: -6...0...6Mvar or higher.

Order specifications for above example

Type	TAP-210DG/3	
Connection (See drawing)	1W3	
Measuring range	-15..0..+15MW	
Current transformer ($I_{pri} : I_{sec}$)	500/1A	
Measuring Voltage (U_{nom})	3 x 10kV	
Voltage transformer ($U_{pri} : U_{sec}$)	10k/100	
Auxiliary voltage (U_{aux})	220V AC	
Output signal	-10..0..+10V	

Dimensional details

All dimensions in mm

Weight: max. 0.5 kg max. 0,35 kg

Transducers for DIN rail mounting Recommended distance between mounted transducers: 30 mm

Due to our continuous development we reserve the right to supply equipment which may vary from the described.



DEIF A/S, Frisenborgvej 33
 DK-7800 Skive, Denmark

Tel.: +45 9614 9614, Fax: +45 9614 9615
 E-mail: deif@deif.com, URL: www.deif.com

