

## Multi-instrument type MIQ96-2

4189320011B (UK)

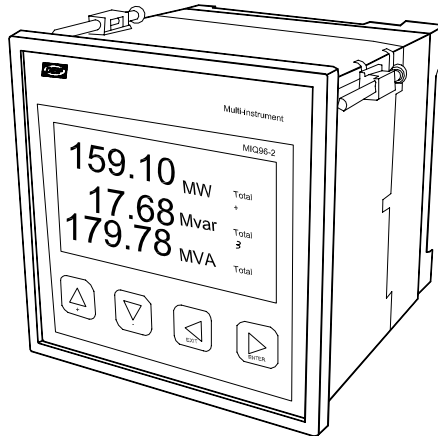

- All 1- or 3-phase AC measurements (RMS) in one unit:
  - $U_{RMS}$ ,  $I_{RMS}$ ,  $f$
  - $P$ ,  $Q$ ,  $S$ ,  $PF$  ( $\cos \varphi$ )
  - kWh, kvarh, kVA
  - MD, THD
- Programmable CT and VT ratio
- Programmable connections 1W, 1W3, 2W3, 1W4, 3W4
- 2 outputs for kWh export, kvarh export or limit switch
- Serial output



DEIF A/S  
Frisenborgvej 33, DK-7800 Skive  
Denmark

Tel.: (+45) 9614 9614  
Fax: (+45) 9614 9615  
E-mail: [deif@deif.com](mailto:deif@deif.com)





## List of contents

<b>1.</b>	<b>Warnings, regular information and remarks referring to CE-marking</b> .....	<b>3</b>
<b>2.</b>	<b>Application and description of function</b> .....	<b>3</b>
<b>3.</b>	<b>Options</b> .....	<b>4</b>
<b>4.</b>	<b>Valid measurements</b> .....	<b>4</b>
<b>5.</b>	<b>Measured parameters</b> .....	<b>6</b>
<b>6.</b>	<b>Display and key-pads</b> .....	<b>7</b>
<b>7.</b>	<b>Menus</b> .....	<b>8</b>
7.1	Display of measuring quantities for connection 3W4 (4u), 1W4 (4b), 2W3 (3u) and 1W3 (3b) .....	8
7.2	Display of measuring quantities for connection 1W (1b).....	12
<b>8.</b>	<b>Watt and var meters</b> .....	<b>15</b>
8.1	Displaying of measuring energy .....	15
8.2	Measuring of energy.....	16
<b>9.</b>	<b>Maximum demands (MD)</b> .....	<b>18</b>
9.1	Display of maximum demands (MD) .....	18
9.2	Thermal demand .....	19
9.3	Fixed window .....	20
9.4	Sliding window .....	21
<b>10.</b>	<b>Display of current</b> .....	<b>22</b>
10.1	Current THD (total harmonic distortion) .....	22
<b>11.</b>	<b>Display of voltage</b> .....	<b>23</b>
11.1	Voltage THD (total harmonic distortion).....	24
<b>12.</b>	<b>Display of active, reactive and apparent power</b> .....	<b>24</b>
<b>13.</b>	<b>Display of power factor PF (cos <math>\phi</math>) and frequency</b> .....	<b>26</b>
<b>14.</b>	<b>Display of real time clock</b> .....	<b>26</b>
<b>15.</b>	<b>Display of the menu "Setting"</b> .....	<b>27</b>
<b>16.</b>	<b>Installation</b> .....	<b>28</b>
16.1	Mechanical installation .....	28
16.2	Electrical installation.....	29
16.3	Connection for aux. supply .....	31
16.4	RS485 Modbus .....	31
16.5	Connection for relay outputs.....	32
<b>17.</b>	<b>Setting</b> .....	<b>33</b>
17.1	Setting of language .....	33
17.2	Other settings.....	35
17.3	Connection.....	36
17.4	Communication (option) .....	38
17.5	Maximum demand (MD) calculations .....	39
17.6	Reset MD.....	40
17.7	Pulse output (setting of parameters of impulse outputs) (option).....	42
17.8	Clock (setting of real time clock) .....	43
17.9	Display (setting of display parameters).....	44
17.10	Language (setting of language).....	44
<b>18.</b>	<b>Password</b> .....	<b>45</b>
<b>19.</b>	<b>Battery replacement</b> .....	<b>47</b>
19.1	Instructions for replacement.....	48

## **1. Warnings, regular information and remarks referring to CE-marking**

In this manual installations and working instructions for the multi-instrument MIQ96-2 are found. Installation as well as use of the MIQ96-2 will involve working with dangerous currents and voltages. Professionals must handle these areas. DEIF does not take on responsibility for the use and installation. If any doubt comes up concerning the installation or use of the system, on which the MIQ96-2 is to be used for measurement, the person responsible for the power installation should be contacted.

The MIQ96-2 is CE-marked according to the EMC-directive for housing and light industry, which normally covers the most common use of the multi-instrument.

Important: CTs must be short-circuited, before the wires are moved from terminals on the multi-instrument.

The delivery contains:

- Multi-instrument MIQ96-2
- User's manuals

## **2. Application and description of function**

The MIQ96-2 multi-instrument is a microprocessor-based unit for measurement of all electrical values in a 1- or 3-phase grid. Application of this unit is possible in all installations where these parameters are to be measured. All measured values are shown on the built-in display. Moreover the measurements can be transmitted as digital output and RS485 (see options).

The MIQ96-2 can replace many analogue instruments in installations for measuring of electrical values and can be used as a conventional instrument and/or as a unit for transmitting values by the serial communication to a remote control base. Also the digital outputs can be connected to a local control system.

All kinds of grids can be connected to the multi-instrument. Both with and without neutral - as well as balanced and unbalanced load. The unit contains all necessary loops for measurements and all values are displayed on an LCD. Information is presented in clear text and shown as actual values.

Characteristic of the MIQ96-2 is the flexible set-up for different grid connections, CTs, VTs, languages et cetera, which ensures the user an easy adaptation of the unit to the wanted application. The set-up parameters and the reset of counters and peak values can be protected by passwords.



### 3. Options

- Option 1: The RS485 remote control of all values and possible changes of set-up, reset of counters and peak values.  
The MIQ96-2 implements a subset of the AEG Modicon Modbus RTU serial communications standard.  
Serial Interface Manual and free utility software can be downloaded from DEIF's homepage [www.deif.com](http://www.deif.com).
- Option 2: Relay output for kWh import and kvarh import.

### 4. Valid measurements

The MIQ96-2 is supplied configured in 3-phase 4-wire unbalanced. This variation may be reconfigured via the front panel or remote communications as follows:

- 1b (1W) Single phase connection.
- 3b (1W3) Three-phase three-wire connection with balanced load.
- 3u (2W3) Three phase three-wire connection with unbalanced load.
- 4b (1W4) Three-phase four-wire connection with balanced load.
- 4u (3W4) Three-phase four-wire connection with unbalanced load.

Also see the external wiring diagram section 16.2 page 29.

Parameter	Connection type				
	1W	1W3	1W4	3W4	2W3
$U_1$	•		•	•	
$U_2$			•	•	
$U_3$			•	•	
$\bar{U}$	•		•	•	
$U_{12}$		•	•	•	•
$U_{23}$		•	•	•	•
$U_{31}$		•	•	•	•
$\bar{U}\Delta$		•	•	•	•
$\varphi_{12}$		•	•	•	•
$\varphi_{23}$		•	•	•	•
$\varphi_{31}$		•	•	•	•
f	•	•	•	•	•
$I_1$	•	•	•	•	•
$I_2$				•	•
$I_3$				•	•

Parameter	Connection type				
	1W	1W3	1W4	3W4	2W3
$I_t$	•	•	•	•	•
$I_n$				•	
$P_1$	•		•	•	
$P_2$			•	•	
$P_3$			•	•	
$P_t$	•	•	•	•	•
$\cos\varphi_1$	•		•	•	
$\cos\varphi_2$			•	•	
$\cos\varphi_3$			•	•	
$\cos\varphi_t$	•	•	•	•	•
$Q_1$	•		•	•	
$Q_2$			•	•	
$Q_3$			•	•	
$Q_t$	•	•	•	•	•
$S_1$	•		•	•	
$S_2$			•	•	
$S_3$			•	•	
$S_t$	•	•	•	•	•
THD ( $U_1$ )	•		•	•	
THD ( $U_2$ )			•	•	
THD ( $U_3$ )			•	•	
THD ( $U_{12}$ )		•	•	•	•
THD ( $U_{23}$ )		•	•	•	•
THD ( $U_{31}$ )		•	•	•	•
THD ( $I_1$ )	•	•	•	•	•
THD ( $I_2$ )				•	•
THD ( $I_3$ )				•	•

## 5. Measured parameters

Instantaneous measurements	Parameters
Phase voltages	$U_1, U_2, U_3$
Average phase voltage	$\overline{U}$
Line voltages	$U_{12}, U_{23}, U_{31}$
Average line voltage	$\overline{U\Delta}$
Angle between phases	$\varphi_{12}, \varphi_{23}, \varphi_{31}$
Current	$I_1, I_2, I_3, I_t$
Neutral current	$I_n$
Active power	$P_1, P_2, P_3, P_t$
Reactive power	$Q_1, Q_2, Q_3, Q_t$
Apparent power	$S_1, S_2, S_3, S_t$
Power factor	$\cos\varphi_1, \cos\varphi_2, \cos\varphi_3, \cos\varphi_t$
THD (total harmonic distortion)	THD ( $I_1, I_2, I_3, U_1, U_2, U_3, U_{12}, U_{23}, U_{31}$ )
Frequency	$f$
<b>Integrated / maximum demands</b>	
Maximum demand	$I_t, P_t, Q_t, S_t$
Energy	$Wh_t, varh_t$

## 6. Display and key-pads

The graphic LCD with yellow/green backlight is used for presentation of measured values and for displaying of the chosen function during set-up.

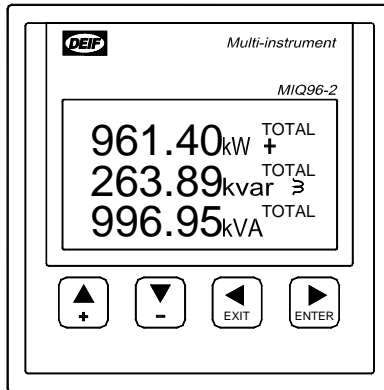

**Up arrow key.** Up through the main menus.  
+ increases a value in the menu "Setting".



**Down arrow key.** Down through the main menus.  
- decreases a value in the menu "Setting".



**Left arrow key.** Left through the sub-menus.  
"Exit" - skip of action by key-in or by changing in the menu "Setting".



**Right arrow key.** Right through the sub-menus.  
"Enter" - accept of changes in the menu "Setting" or reset of counters and peak values.

## 7. Menus

### 7.1 Display of measuring quantities for connection 3W4 (4u), 1W4 (4b), 2W3 (3u) and 1W3 (3b)

The following displays appear at 3W4 (4u) connection. Displays for other connections are alike except from 1W (1b).

Arrows between displays indicate which display occurs on the instrument when the corresponding key is pressed.

If the password function is deactivated, the display for entering of password will not appear and access will be obtained directly.

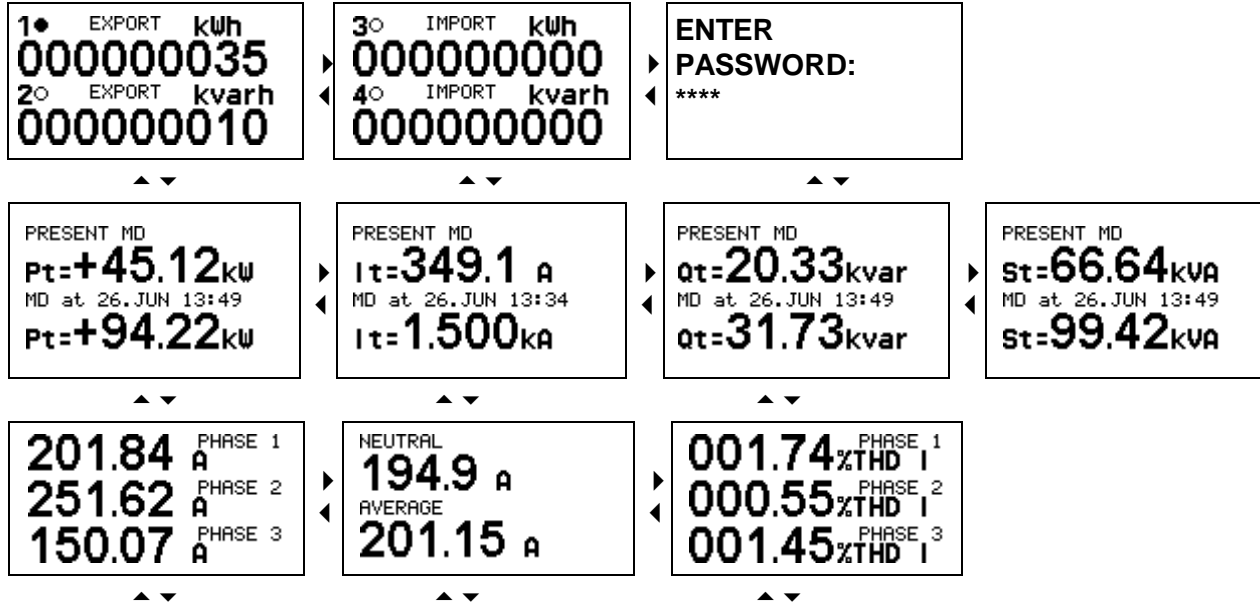





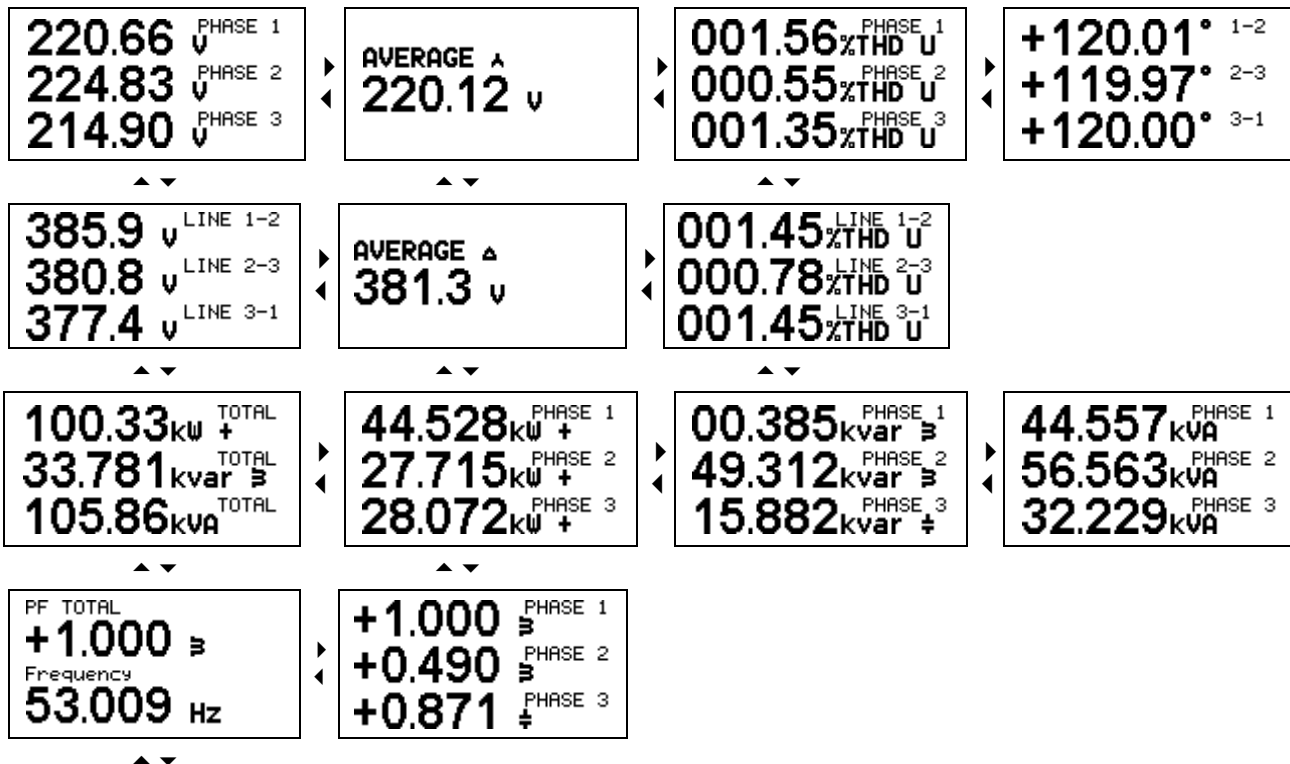

26 . JUN . 2001

**13:58:14**



**SETTING**

## 7.2 Display of measuring quantities for connection 1W (1b)

The following displays appear.

1● EXPORT kWh  
**000000035**  
2○ EXPORT kvarh  
**000000010**

3○ IMPORT kWh  
**000000000**  
4○ IMPORT kvarh  
**000000000**

ENTER  
PASSWORD:  
\*\*\*\*

PRESENT MD  
Pt=**+45.12**kW  
MD at 26.JUN 13:49  
Pt=**+94.22**kW

PRESENT MD  
It=**349.1** A  
MD at 26.JUN 13:34  
It=**1.500**kA

PRESENT MD  
Qt=**20.33**kvar  
MD at 26.JUN 13:49  
Qt=**31.73**kvar

PRESENT MD  
St=**66.64**kVA  
MD at 26.JUN 13:49  
St=**99.42**kVA

**201.87** A  
**001.74**%THD I

**220.77** V  
**001.56**%THD U

067.6 V  
0853.5 A  
057.69 kW +



44.545 kW +  
00.368 kvar ≡  
44.551 kVA



PF  
+1.000 ≡  
Frequency  
53.007 Hz



26. JUN. 2001  
13:58:14





---

**SETTING**

## 8. Watt and var meters

### 8.1 Displaying of measuring energy

Pictures of the measured energy are identical for all kinds of grid connections. Please notice that an indicator is flashing just to the right of the counter number when the counter is active.

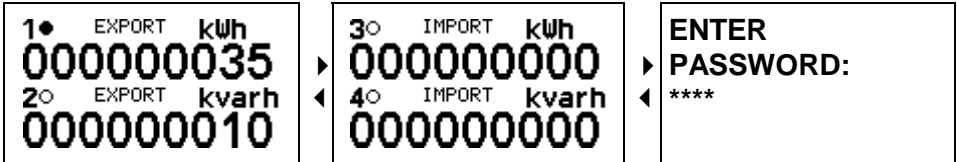

To reset the energy value it is necessary to enter a password of level L1 or L2. When the password is entered, the following is displayed.

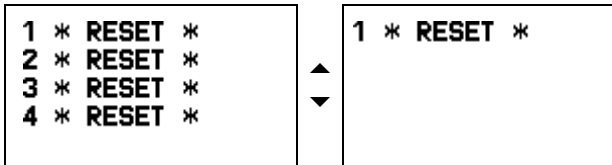

With the  $\blacktriangle$   $\blacktriangledown$  keys the values of the energy, which will be reset, are selected. The energy value is reset when the  $\blacktriangleright$  key is pressed for five seconds. In the meantime a count-down of 5 seconds is made. After five seconds the picture of exports kWh and kvarh is displayed again, and the chosen counter is reset.

Please notice that all 4 counters can be reset simultaneously, if the  $\blacktriangleright$  key is pressed before using the  $\blacktriangle$   $\blacktriangledown$  keys.

If the  $\blacktriangleright$  key is released before the expiration of 5 seconds, the energy value is not reset.

The resetting procedure is equal for all data resetting in the multi-instrument.

## 8.2 Measuring of energy

In the figure below a 3W4 (4u) connection is shown to illustrate the direction of energy according to the 4 counters for kWh and kvarh.

The direction of energy is identical for all other connections.

The consideration of import and export of energy.

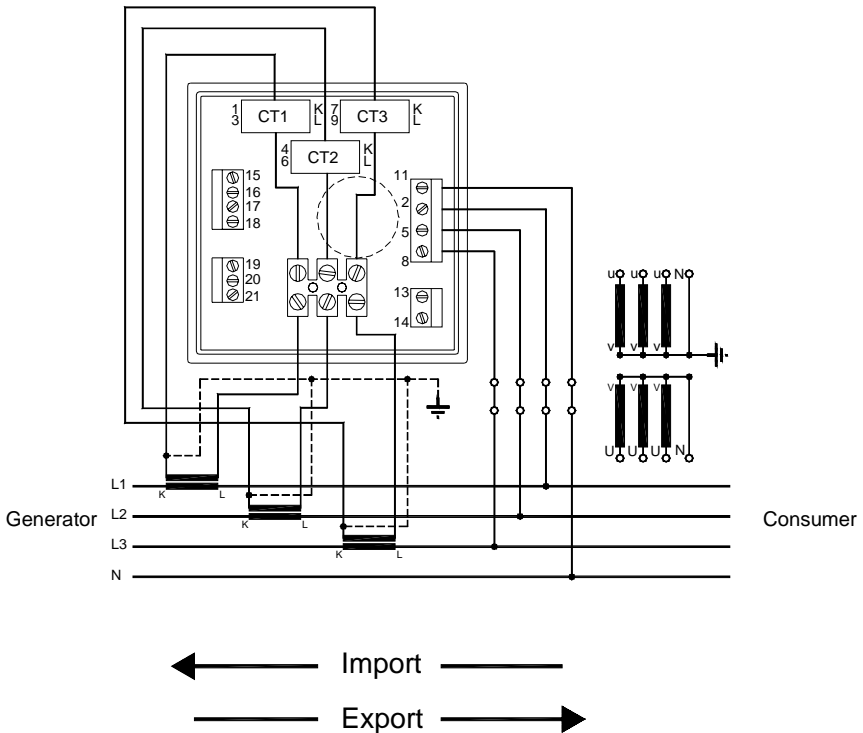



The function of the 4 counters, according to the displacement between voltage and current, is illustrated in the figure below.

The MIQ96-2 has 2 relay outputs (see section 16.5 page 32), relay output 1 is corresponding to counter 3 (export kWh) and relay output 2 is corresponding to counter 4 (export kvarh).

Change of this set-up can only be done through communication.

Note:

As default counters 1 and 2 are set to import, and counters 3 and 4 are set to export (different from the example).

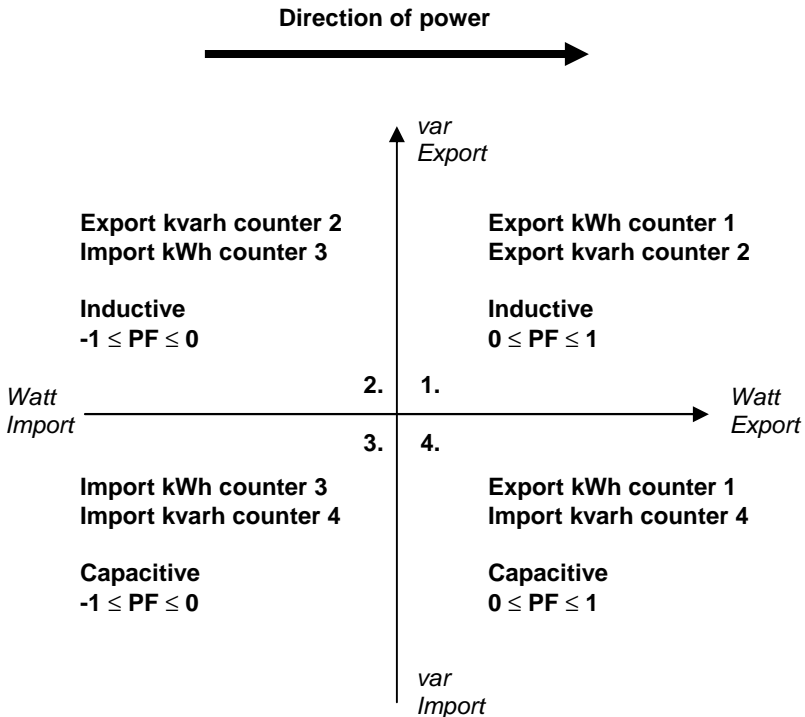
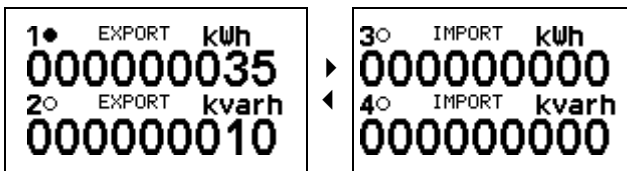



## 9. Maximum demands (MD)

### 9.1 Display of maximum demands (MD)

The MIQ96-2 provides demand values from a variety of average demand values (**Thermal**/bimetal instrument, **Fixed window** and **Sliding window**) for the following electrical parameters:

Total active power	( $P_t$ )
Sum of phase currents	( $I_t$ )
Total reactive power	( $Q_t$ )
Total apparent power	( $S_t$ )

#### Maximum demands

The MIQ96-2 displays the present or “dynamic” maximum demand (value below “PRESENT MD”). The MIQ96-2 also stores the maximum demand value since last reset and its corresponding time stamp, visible either from the MIQ96-2 display or remote communications link (value below “MD at DD.MM HH:MM”).

Only one of the following modes 1) **Thermal**, 2) **Fixed window** or 3) **Sliding window** can be active at a time. Set-up – see the menu “Settings” → “Maximum demands” section 17.5 page 39.

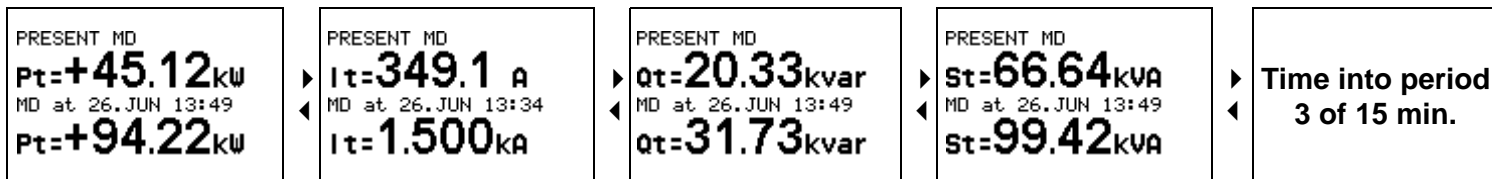

## 9.2 Thermal demand

The thermal demand option will provide an exponential thermal characteristic, based on the bimetal element principle.

Maximum demand and the time of its occurrence are stored in the unit. The period (Time C.) can be set in the range 1 to 255 minutes.

When "Thermal demand" mode is used, "Time into period" is not displayed.

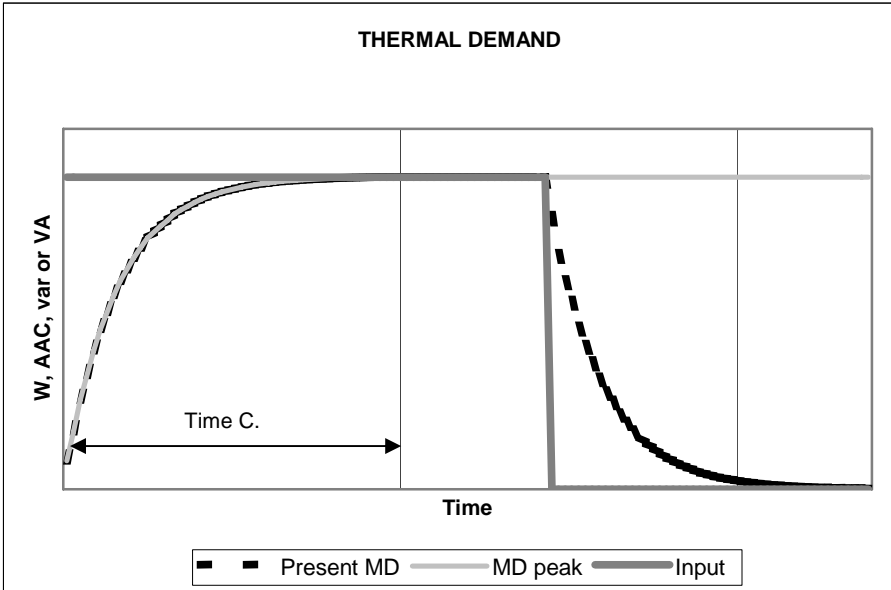

### 9.3 Fixed window

The fixed interval mode calculates an average demand value over a fixed time period. The period (Time C.) can be set in the range 1 to 255 minutes.

“Time into period” will be active and show the remaining time of a period until **present MD** and **MD peak** will be updated next. When  $P_t$ ,  $I_t$ ,  $Q_t$ ,  $S_t$  displays have been updated, a new time period starts and a new average demand is measured for the next period. Display “Time into period” shows 0 of xx min.

Example:

Mode: **Fixed window**

Time C.: **8 min.**

Present MD and MD peak: **Reset at time 0 min.**

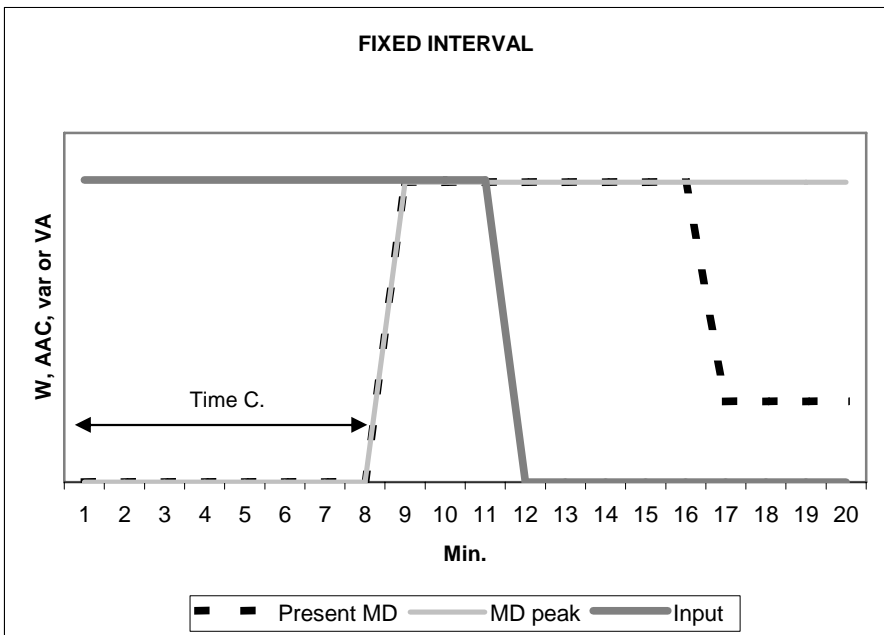

## 9.4 Sliding window

The sliding window technique allows the user to divide the time period into a number of sub-periods. The average demand value over the demand total period is displayed, however, after the initial demand period has expired, the demand value will be updated by the addition of a further sub-period, thus creating a "sliding window" measurement.

The number of sub-periods can be set from 2 to 15.

The sub-period (Time C.) can be set in the range 1 to 255 minutes.

### Example:

A total period is 8 minutes (consisting of 4 sub-periods of 2 minutes duration). The **present MD** and **MD peak** are reset at time 0 min. "Time into period" will consist of 2 minutes and make an update of **present MD** and **MD peak** every second minute. After the first 4 sub-periods (1 total period) have expired, a new window will be added and the oldest window will be deleted, thus creating a sliding window. This will always give an average demand value for the last 4 sub-periods.

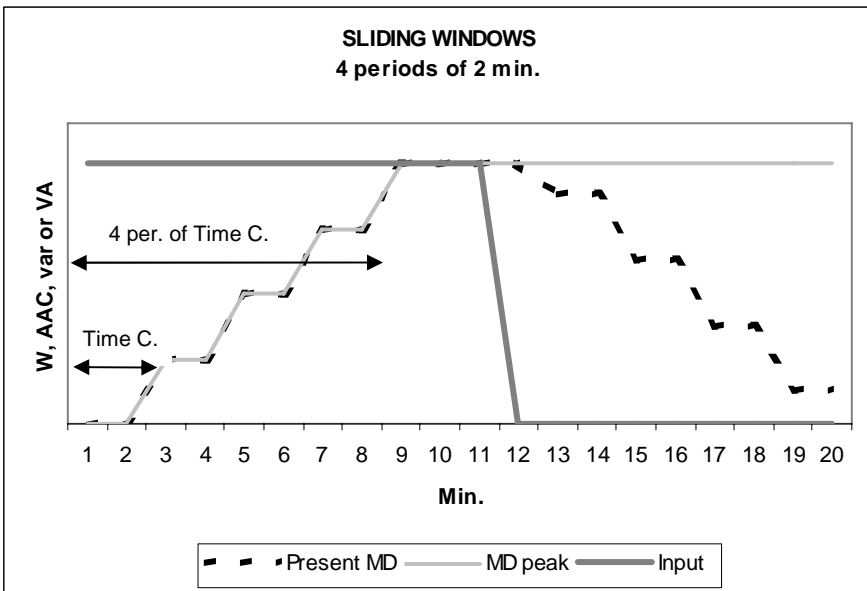

## 10. Display of current

The MIQ96-2 measures the true RMS value of the phase currents ( $I_1, I_2, I_3$ ) connected to the unit.

$$I_{RMS} = \sqrt{\frac{\sum_{n=1}^N i_n^2}{N}}$$

N is the number of sampled values within a period and  $i_n$  is the sampled value.  
N is 64 for the MIQ96-2.

The neutral current ( $I_n$ ), average current ( $I_a$ ) and the sum of all phase currents ( $I_t$ ) are calculated from the three phase currents.

The available phase currents, neutral current and average current can be viewed on the display or via the remote communications link while the sum of all phase currents is visible only via the remote communications link.

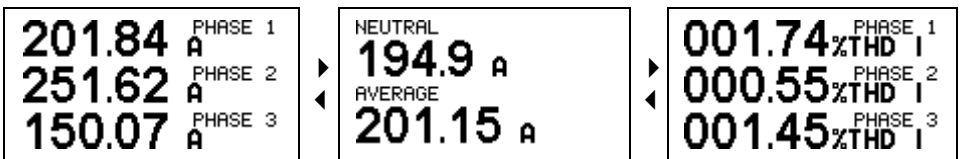

### 10.1 Current THD (total harmonic distortion)

The THD is calculated for phase currents. It is expressed as a percentage of harmonics due to fundamental frequency.

The multi-instrument uses a true RMS (Root Mean Square) measurement technique which provides accurate measurement with harmonics present up to the 15<sup>th</sup> harmonic.

$$\frac{\sqrt{\sum_{n=2}^{\infty} I_n^2}}{I_1} \cdot 100\% = THD\%$$

## 11. Display of voltage

All connections of the MIQ96-2, except in the 3-wire mode (1W3 and 2W3), measure the true RMS value of the phase voltages ( $U_1$ ,  $U_2$ ,  $U_3$ ) connected to the unit (only  $U_1$  for 1W connection).

The three line voltages ( $U_{12}$ ,  $U_{23}$ ,  $U_{31}$ ), average phase voltage ( $\overline{U}_\Delta$ ) and average line voltage ( $\overline{U}_\Delta$ ) are calculated from these measured parameters.

$$\text{Calculation of line voltage: } U_{xy} = \sqrt{U_x^2 + U_y^2 - 2U_x U_y \cos \varphi_{xy}}$$

For 3-phase 3-wire balanced systems (1W3) and 3-phase 3-wire unbalanced system (2W3), the MIQ96-2 creates a virtual neutral internally.

The available phase, line and average voltages can be viewed on the MIQ96-2 display or via the remote communications link.

Angles between phases indicate the angles between the vectors of phase voltages. A positive mark indicates correct phase sequence, while a negative mark indicates an opposite phase sequence of the measured system.

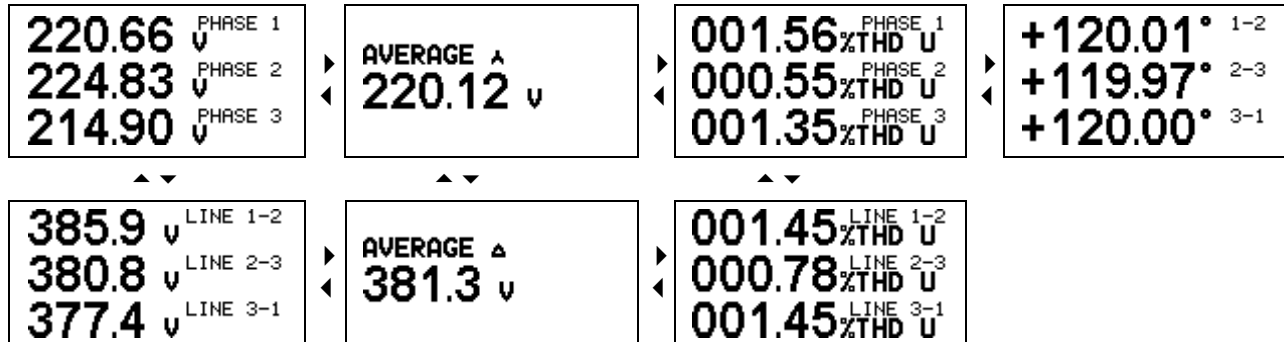

### 11.1 Voltage THD (total harmonic distortion)

The THD is calculated for phase voltages and line voltages. It is expressed as a percentage of harmonics due to fundamental frequency.

The MIQ96-2 uses a true RMS (Root Mean Square) measurement technique which provides accurate measurement with harmonics present up to the 15<sup>th</sup> harmonic.

$$\frac{\sqrt{\sum_{n=2}^{\infty} U_n^2}}{U_1} \bullet 100\% = THD\%$$

## 12. Display of active, reactive and apparent power

The MIQ96-2 provides accurate measurement of active ( $P_1, P_2, P_3, P_t$ ), reactive ( $Q_1, Q_2, Q_3, Q_t$ ) and apparent power ( $S_1, S_2, S_3, S_t$ ).

### Active power:

Calculation of  $P_{1, 2, 3}$ : 
$$P = \sum_{n=1}^N \frac{u_n \times i_n}{N}$$
 N (64) is the number of samples, and  $u_n$  and  $i_n$  are sampled values within 1 period.

Calculation of  $P_t$ : 
$$P_t = P_1 + P_2 + P_3$$

### Reactive power:

Calculation of  $Q_{1, 2, 3}$ : 
$$Q = \sqrt{(UI)^2 - P^2}$$

Calculation of  $Q_t$ : 
$$Q_t = Q_1 + Q_2 + Q_3$$

### Apparent power:

Calculation of  $S_{1, 2, 3}$ : 
$$S_1 = \sqrt{P_1^2 + Q_1^2}$$

Calculation of  $S_t$ : 
$$S_t = \sqrt{P_t^2 + Q_t^2}$$



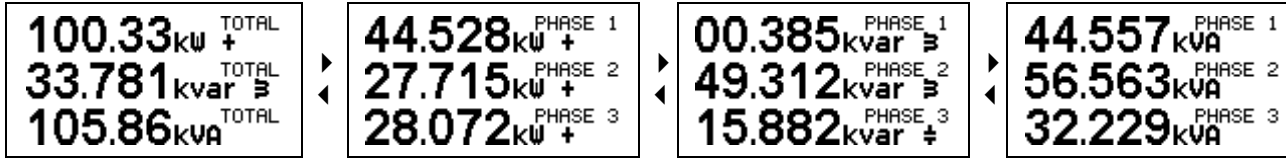

For four-wire systems (1W4, 3W4) the powers are calculated both for each phase separately and as a total.

For three-wire (1W3, 2W3) and single phase systems (1W) only total power values are measured.

When displaying active power, a positive sign indicates export power while a negative sign indicates import power (see section 8.2 page 16).

When displaying reactive power, a coil symbol indicates an inductive load while a capacitor symbol indicates a capacitive load (see section 13 page 26).

All the available power parameters can be viewed using either the MIQ96-2 display or the remote communications link.

### 13. Display of power factor PF (cos $\phi$ ) and frequency

The power factor is calculated as a quotient of active and apparent power for each phase separately (cos $\phi_1$ , cos $\phi_2$ , cos $\phi_3$ ) and as a total (cos $\phi_t$ ).

Calculation of cos $\phi_1$ :  $\cos\phi_1 = P_1/S_1$

Calculation of cos $\phi_t$ :  $\cos\phi_t = P_t/S_t$

Cos $\phi_1$ , cos $\phi_2$ , cos $\phi_3$  for each phase are only displayed in a 3W4 connection and set-up.

A positive sign and a coil symbol indicate an inductive load while a negative sign and a capacitor symbol indicate a capacitive load (see section 8.2 page 16).

All available power factor parameters can be read from the display or via the remote communications link.

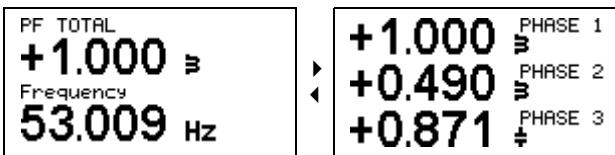

The system frequency is calculated from the time period of the measured voltage and can be viewed both from the display and the remote communications link.

### 14. Display of real time clock

The MIQ96-2 is provided with a built-in real time clock. It is intended for registration of time of the occurrence of MDs, and for synchronisation of the time interval.

On delivery from DEIF, the MIQ96-2 is set up with CET time (winter time). Switching from winter time to summer time must be done manually in the menu "Setting".

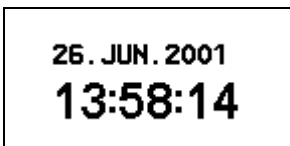

## 15. Display of the menu "Setting"

In the menu "Setting" the software version number is displayed when the left arrow key is pressed.

Display "INFO" shows information about the serial number of the instrument. This number is also printed on the label along with hardware and software version, working hours in days, hours and minutes and the inner temperature of the MIQ96-2.

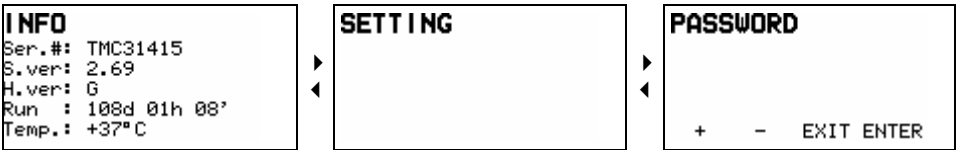

## 16. Installation

In this section the line of general directions for the installation of the MIQ96-2 are indicated. Installation as well as use of the MIQ96-2 will involve working with dangerous currents and voltages. Professionals must handle these areas. DEIF does not take on responsibility for the use and installation. If any doubt comes up concerning the installation or use of the system, on which the MIQ96-2 is to be used for measurement, the person responsible for the power installation should be contacted.

**Before commissioning:** Check voltage and revolving field. These must be correct.

**Warning:** Missing or wrong voltage and other input errors might cause malfunction and damage on the MIQ96-2.

### 16.1 Mechanical installation

Dimensions (in mm).

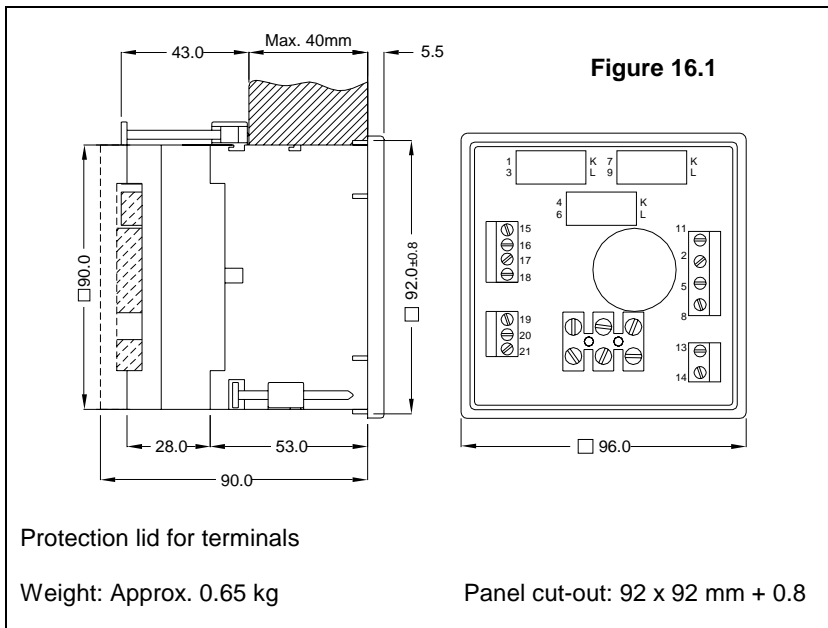

1. Remove the 4 screws before inserting the instrument in the panel cut-out, and then replace and tighten the screws until the instrument is fastened in the panel.
2. Remove the folio protection from the display.

## 16.2 Electrical installation

Connection for measuring voltage and measuring current:

3. Choose one of the connections from the figures below and make the connection according to this for input voltage and input current.

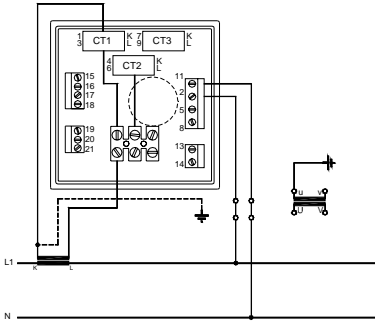

Figure 16.2.1 1W connection (1b)

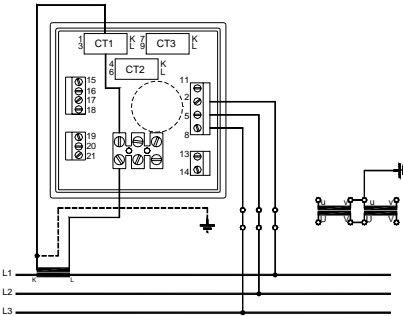

Figure 16.2.2 1W3 connection (3b)

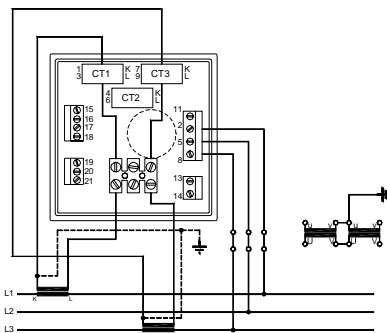
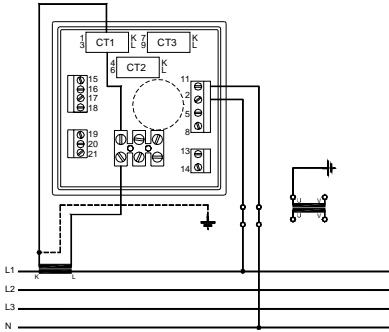
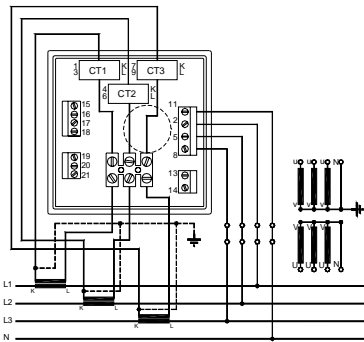

Figure 16.2.3 2W3 connection (3u)



**Figure 16.2.4 1W4 connection (4b)**



**Figure 16.2.5 3W4 connection (4u)**

### 16.3 Connection for aux. supply

4. Make the connection for aux. supply to terminals 13 and 14.

### 16.4 RS485 Modbus

5. Make the connection for communication RS485 as shown in figure 16.4 below.

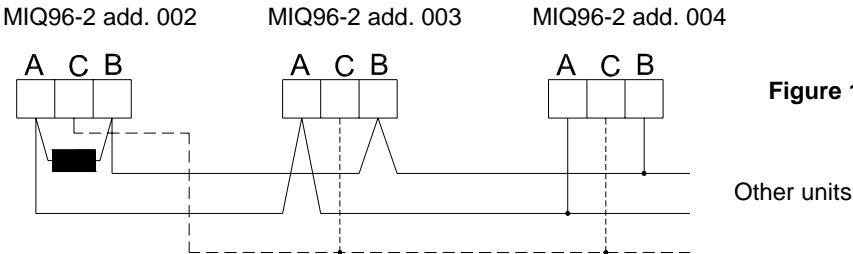

Figure 16.4

6. Screened twisted pair must be used (min. 0.5 mm<sup>2</sup>).
7. Max. 32 multi-instruments in one string.

For RS485 communications the PC will require either an internal RS485 communications port or an external RS232/RS485 interface. In both cases the device must provide automatic RS485 data flow control.

The maximum connection length is 1000 metres.

Conductors A and B should be terminated with a 120Ω terminating resistor at the end of a string.

RS485 connections:

MIQ96-2	RS485
A	DATA +
C	GND
B	DATA -

Note:

It is recommended only to connect terminal C (GND), if solely MIQ96-2s are connected. In other situations, leave the terminal C open.

### 16.5 Connection for relay outputs

Output 1: Potential free relay for kWh export (counter 3).

Output 2: Potential free relay for kvarh export (counter 4).

Note:

The set-up for kWh and kvarh counters for relay 1 and 2 respectively can only be changed via communication port and the utility software.

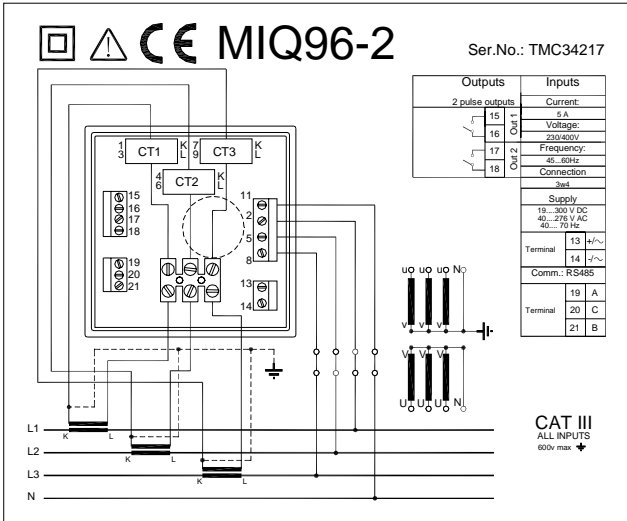

Figure 16.5



## 17. Setting

### 17.1 Setting of language

- The MIQ96-2 is delivered without requirement for password. (Password is disabled). See section 18 page 45 for activation of password levels.
- The MIQ96-2 is delivered with set-up for English language.

Please follow the guidance below for change of language:

1. Put on power for supply of the MIQ96-2.

The value of the measured energy export is displayed 5 seconds after power up (see figure 17.1).



**Figure 17.1**

Now follow the instructions below for setting of the unit for the wanted language.

The arrows indicate which button to push.

2. Push the ▼ key and "Setting" is displayed. (The display returns to the picture shown in figure 17.1 if no keys are pushed for 5 seconds).
3. Push the ► key and "Password" will appear. (The display returns to the picture shown in figure 17.1 if no keys are pushed for 30 seconds. This is general when operating in the menu "Setting").
4. Push the ▼ key and "Language" is displayed.
5. Push the ► key and "English" will appear below "Language".
6. Push the ► key and "Set" will appear. Now the MIQ96-2 is ready for change of language.
7. Push the ▲ or ▼ key until the wanted language appears, then push the "Enter" key, and the chosen language will appear.

**LANGUAGE**



**LANGUAGE:  
ENGLISH**



**LANGUAGE:  
ENGLISH  
SET**

## 17.2 Other settings

Follow the instructions on the following pages for general set-up of the unit before commissioning.

On the overview below the sub-menus for the menu "Setting" are indicated.

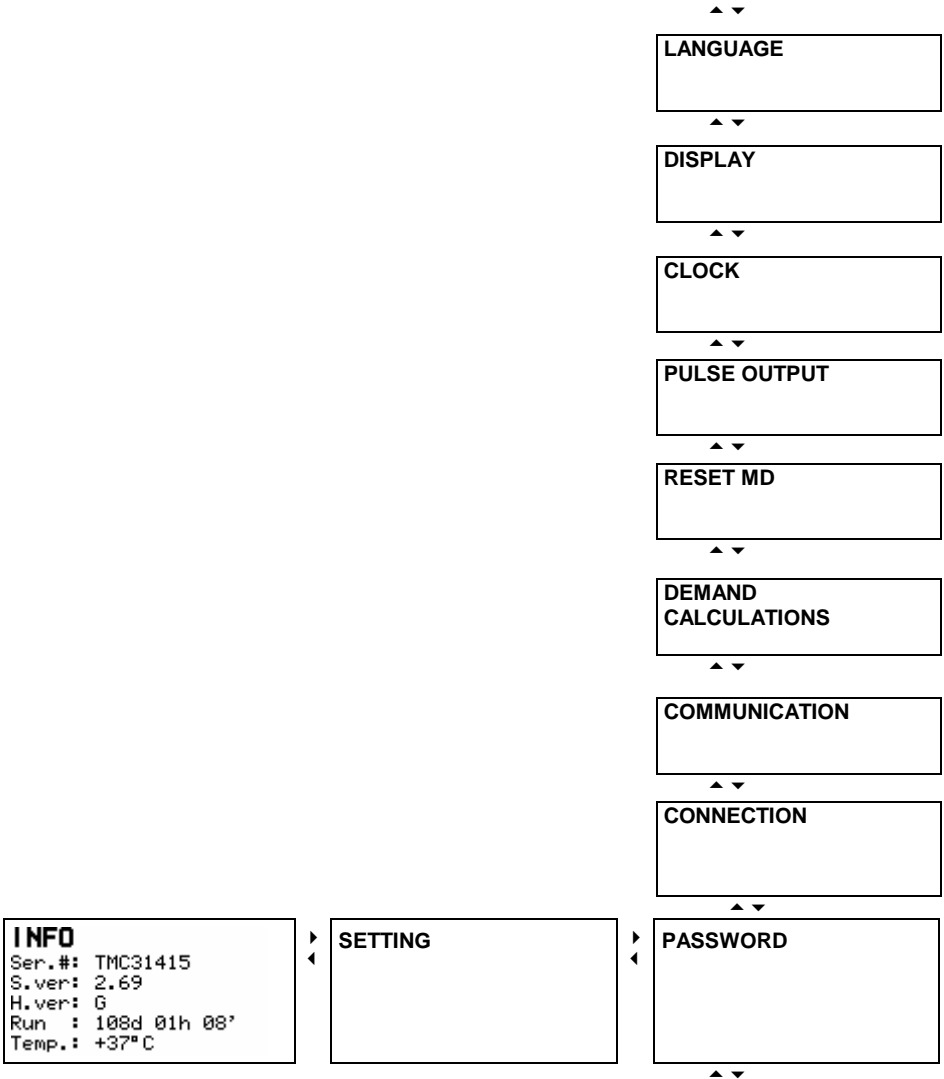

### 17.3 Connection

Setting of current/voltage transformer ratio and input requires password L2. For a survey of individual values it is not necessary to set the password.

CT-ratio

When setting the current ratio, only the primary value is set. The secondary value is defined with the version of the multi-instrument (1A or 5A).

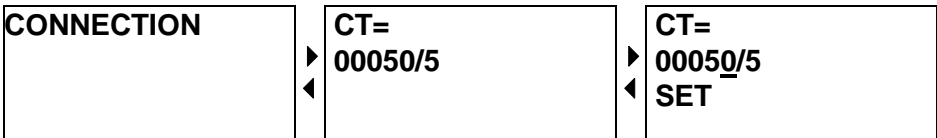





Ratios are selected as shown in the table below.

Ratio for current transformer	/1A	Ratio step in MIQ96-2
1...63	1...63	1
65...315	65...315	5
320...630	320...630	10
650...3150	650...3150	50
4000	4000	

Ratio for current transformer	/5A	Ratio step in MIQ96-2
1...63	5...315	5
65...315	325...1575	25
320...630	1600...3150	50
650...3150	3250...15750	250
4000	20000	

Maximum ratio for current transformers is 4000.

When **Set** is displayed, the digit is selected by means of the  and  keys (the selected digit is underlined). The primary value of the current transformer is selected with the  or  keys.

When the current ratio value is selected, the  key must be pressed until **Set** disappears. In this way the multi-instrument has received a new value of the current ratio.

With the **◀** key the parameter setting range is exited, and an eventual modification is not considered.

**VT-ratio**

Both the primary and secondary values of the VT ratio may be set. The values are set in the same manner as described for the CT ratio. When setting the voltage transformer primary value, the decimal point is also set. The decimal point is set with the **▲** and **▼** keys when the decimal point is selected (underlined). By setting of the decimal point, the resolution of the energy display can be changed.

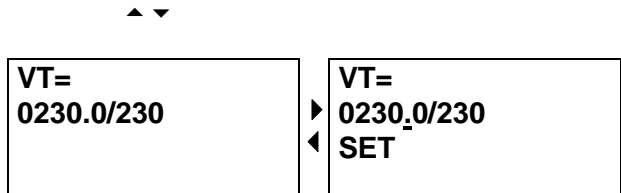

Ratio of the voltage transformer is set as follows:

Setting of secondary voltage:

Voltage range	Voltage step
10...137 V	1 V
140...775 V	5 V

Setting of primary voltage:

Voltage range	Step
0.1...1599.9 V	0.1 V
1...15.999 kV	1 V
10...159.99 kV	10 V
100...1599.9 kV	100 V

## Setting of input connection

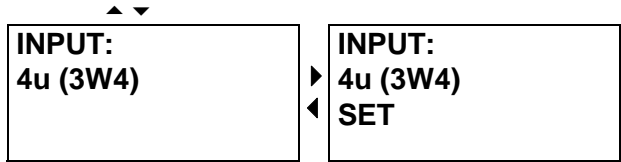

The type of connection is selected with the ▲ or ▼ keys when **Set** is displayed. The type of connection to the power system must be set to match the physical connection implemented. See the physical connections section 16.2 pages 29 and 30.

Connection types:

- 1b (1W) Single phase connection.
- 3b (1W3) Three-phase three-wire connection with balanced load.
- 3u (2W3) Three-phase three-wire connection with unbalanced load.
- 4b (1W4) Three-phase four-wire connection with balanced load.
- 4u (3W4) Three-phase four-wire connection with unbalanced load.

### 17.4 Communication (option)

An L2 password is required to set the communications.

Setting of communication RS BitRate:

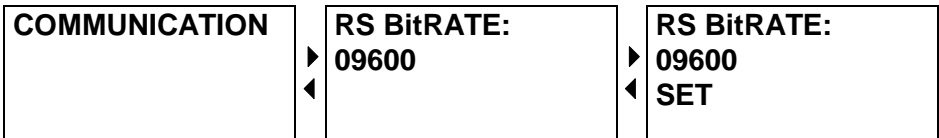

The transmission rate of communication data is set with the ▲ and ▼ keys. The rate values are: 1200, 2400, 4800, 9600, 19200, 38400, 57600 or 115200 Baud.

Setting of communication data form:

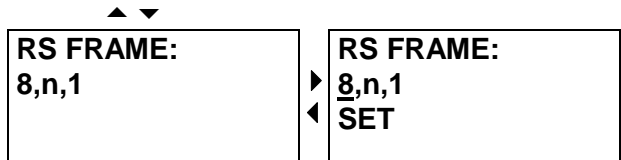

Length: 7, 8 (value 8 is always used for MODBUS RTU).  
 Parity: n (NONE), o (ODD), e (EVEN).  
 Stop bit: 1, 2.

Setting the address:

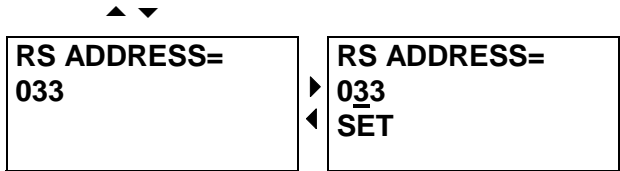

The address can be set within the range from 1 to 247. The addresses must be different for units on the same string.

Address 0 is reserved only for simultaneous transmission of data of the master system to all slave systems. Subordinate systems do not respond with the answer to the master one.

### 17.5 Maximum demand (MD) calculations

Setting of calculation mode of MDs:

A level 2 password must be entered to set maximum demand calculations. Only one of the 3 below modes can be active at a time.

- Thermal mode (Thermal) (bimetal instrument).
- Fixed window (Fixed window).
- A number of sub-windows within the range from 2 to 15 (x Sliding window).

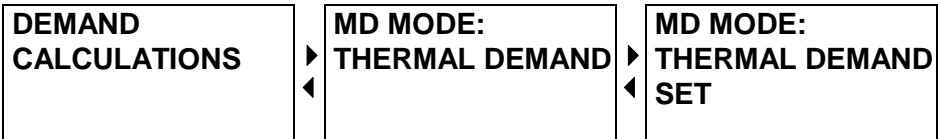

Setting of mode is then done with the ▲ and ▼ keys.

Setting of Time C.:

Setting of the time interval within the range from 1 to 255 minutes. If the interval is set at 0, measurement of MDs is switched off.

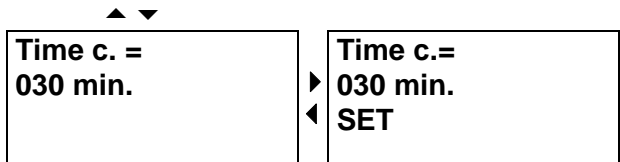



## 17.6 Reset MD

An L1 or L2 password is required to reset or synchronise the MD quantities.

### Synchronisation of time interval:

- **Thermal mode**  
In this mode synchronisation does not have any influence.
- **Fixed window**  
At synchronisation a momentary interval is interrupted, and measurement or calculation of MDs is continued at the next full period.
- **Sliding window**  
At synchronisation a momentary interval of the sub-window is interrupted, and the measurement or calculation of maximum values is continued at the following full period of the next sub-window.



Synchronisation of the time interval is done by pressing the  key for 5 seconds. A count-down of 5 seconds is done. If the  key is released before 5 seconds, the synchronisation of the time interval is not performed.

After the synchronisation the “Time into period” is shown in the display. With this the synchronisation is performed and a new measurement implemented.

### Present MD (resetting of the values in a momentary time interval):

- **Thermal mode**  
MD is reset (Present MD).

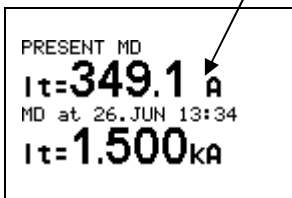

- **Fixed window**  
Value in the current time interval (Present MD) is reset. At the same time synchronisation of the time interval is also performed.
- **Sliding window**  
Momentary values in a sub-window as well as other values of sub-windows in the time interval are reset. At the same time synchronisation of the time interval is performed at the beginning of the first sub-window.



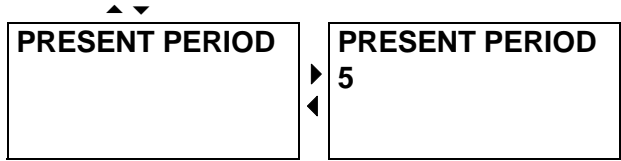

**MD since reset (resetting of recorded MD):**

- **Thermal mode**  
Present MD and stored maximum values are reset.

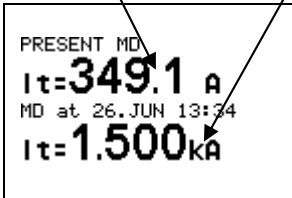

- **Fixed window**  
Value in a current time interval and stored MD are reset. At the same time synchronisation of the time interval is performed.
- **Sliding window**  
Value in the time interval and in all sub-windows as well as stored MD are reset. At the same time synchronisation of the time interval is performed at the beginning of the first sub-window.

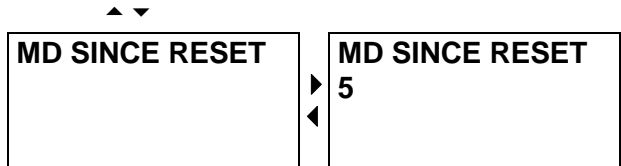

**General:**

After resetting of present MD, the MD window of total active power is displayed. With this the present MD is zero and a new measurement implemented.

After resetting of present MD and MD peak, the total active power is displayed. With this the present MD and MD peak are zero and a new measurement implemented.

The above resetting modes are valid for all maximum demand parameters ( $I_t$ ,  $P_t$ ,  $Q_t$ ,  $S_t$ ) simultaneously.

### 17.7 Pulse output (setting of parameters of impulse outputs) (option)

A level 2 password must be entered to set the pulse outputs.

Setting of impulses for relay output 1:

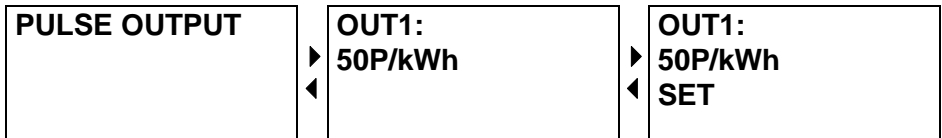

The pulse rate per Wh is set by the  $\blacktriangle$  and  $\blacktriangledown$  keys.

Lowest value: 1P/Wh

Highest value: 20P/GWh

The upper limit of the number of impulses is 4000 impulses per hour.

Setting of impulses for relay output 2:

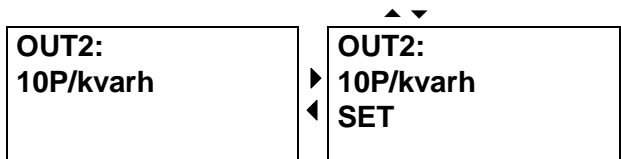

The pulse rate per varh is set by the  $\blacktriangle$  and  $\blacktriangledown$  keys.

Lowest value: 1P/varh

Highest value: 20P/Gvarh

The upper limit of the number of impulses is 4000 impulses per hour.

### 17.8 Clock (setting of real time clock)

Setting of the real time clock requires level L1 or L2 password.

Setting of time:



Setting of date:

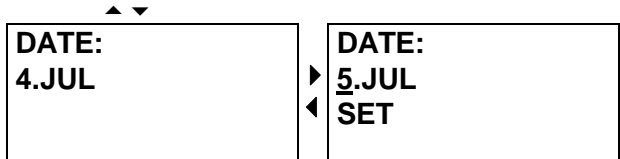

Setting of year:

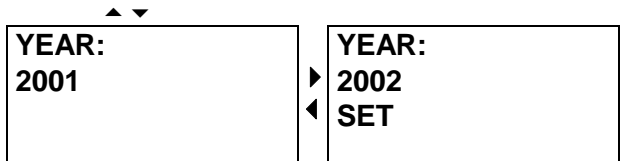

The character, which is to be changed for time and date, is chosen with the **▶** and **◀** keys, and its value is changed with the + and - keys. The **▲** and **▼** keys are used for setting of the year.

Note:

On delivery from DEIF, the MIQ96-2 is set up with CET time (winter time). Switching from winter time to summer time must be done in the menu "Setting" → "Clock" as shown above.

## 17.9 Display (setting of display parameters)

The display settings can be modified without entry of password.

Setting of the contrast:

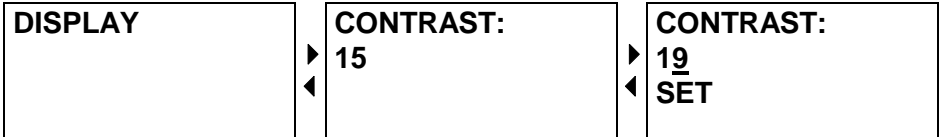

The display contrast is set within the range from 0 to 63.

0: High contrast.  
63: Low contrast.

Setting of illumination intensity:

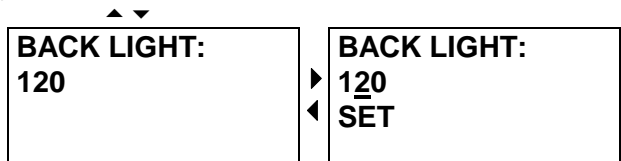

The illumination intensity is set within the range from 0 to 255.

0: Illumination is switched off.  
255: High intensity of illumination.

Setting of display illumination duration:

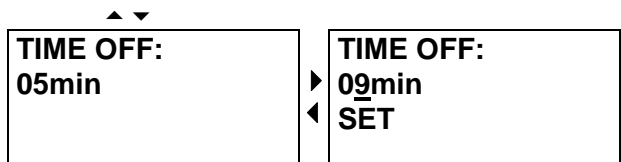

The duration of display illumination is set within the range from 0 to 54 minutes. The display illumination is switched on when one of the 4 keys under the display is activated, and it is switched off after expiration of the set time from the last pressing of a key. If "Time off" is set at 0, the illumination is permanently switched on.

## 17.10 Language (setting of language)

Setting of language - see section 17.1 page 33.

The following languages can be chosen for the MIQ96-2:

English, Danish, German, French, Russian and Spanish.

## 18. Password

Setting of parameters in the multi-instrument is divided into four groups regarding password level:

1. At the lowest level (L0), at which a password is not required, the following display parameters can be set: The contrast of characters, the illumination intensity and the duration of illumination.
2. At the first level (L1) it is possible to change the setting of the real time clock (Clock), resetting of electricity meters and resetting of MD values (Reset MD).
3. The second level (L2) gives access to the first level (L1) and enables setting of all other parameters in the menu "Setting".
4. The backup password (BP) is used if the L1 or L2 password is forgotten and is specific for each serial number. The BP can be obtained on application to the Service and Support department at DEIF A/S and is entered instead of L1 or/and L2. Please remember to state the five-figure id-number of the unit when contacting DEIF A/S. (See section 15 page 27).

Password entry:

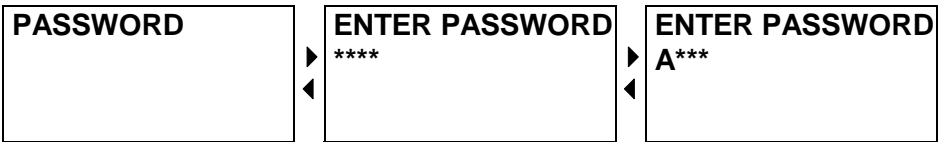

Setting of the L1 level password:

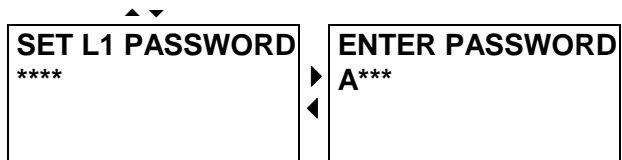

Setting of the L2 level password:

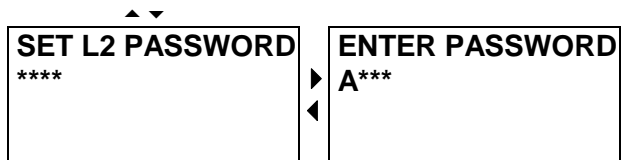

Password cancellation:

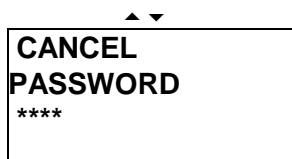



---

A password consists of four letters. Each letter can be chosen from A to Z. Only one character is displayed when the password is entered or set. The other three characters are indicated by \*.

The character is selected with the ► and ◀ keys and modified with the + or – keys.

The multi-instrument detects the level of the entered password. If no key is pressed for 15 minutes, the password is automatically cancelled.

When “Cancel password” is selected, the user can cancel the present password by pressing “Enter”.

Entry of the password via communication (option) or the front panel of the MIQ96-2 gives access to the same rights for resetting and changing of parameters.

The factory set password is AAAA for both levels of password (L1 and L2). AAAA password does not limit the access and corresponds to the level L0.

To protect the setting, the energy counters and the MD functions it is recommended to modify the password on levels L1 and L2 immediately after the commissioning.

Only level L2 settings are protected if L1=AAAA.  
L1 settings are not protected if L2=AAAA.

Procedure for changing of password:

1. Enter password (password for L1) followed by “Enter”.
2. Choose “Set L1 password” followed by “Enter”.
3. Enter the new password for L1 followed by “Enter”.
4. Choose “Set L2 password” followed by “Enter”.
5. Enter the new password for L2 followed by “Enter”.
6. Finally choose “Cancel password” followed by “Enter”.
7. Now the new passwords for L1 and L2 are valid.
8. Disable passwords: Enter “AAAA” for both L1 and L2 in points 3 and 5.

## 19. Battery replacement

For backup of the RTC (real time clock) and the MD (maximum demand) a lithium battery is implemented in the MIQ96-2. The lifetime of the battery is approximately 6 years (typical). High temperature and humidity can shorten the battery's lifetime.

When the battery is flat, a flashing battery indicator is activated in the bottom right-hand corner of the display. When the battery is flat, the RTC and MD measurements are not saved when the power supply is turned off.

Flashing battery indicator

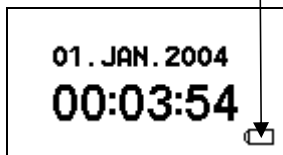

Notice that the flashing battery indicator is only visible when the above window is selected.

## 19.1 Instructions for replacement

1. Disconnect the instrument from measuring grid and power supply.
2. Remove protection cover.
3. Remove battery cover (see the picture below).
4. Remove battery (Varta type: CR2032 lithium battery).
5. Mount the battery with the positive pole up.

