



QUICK START GUIDE



Paralleling and Protection Unit PPU 300



DEIF A/S · Frisenborgvej 33 · DK-7800 Skive
Tel.: +45 9614 9614 · Fax: +45 9614 9615
info@deif.com · www.deif.com

Document no.: 4189341107D

1. Introduction

1.1 About the quick start guide	3
1.1.1 General purpose	3
1.1.2 Software versions	3
1.2 Warnings and safety	3
1.2.1 Safety during installation and operation	3
1.2.2 Controller power supply	3
1.2.3 Factory settings	4
1.2.4 Reset to factory settings	4
1.2.5 Remote-controlled starts	4
1.2.6 Electrostatic discharge	4
1.2.7 Data security	4
1.3 Legal information	4
1.3.1 Trademarks	4
1.3.2 Disclaimer	5
1.3.3 Copyright	5

2. Installation and wiring

2.1 Mount the hardware	6
2.1.1 Controller mounting	6
2.1.2 Display unit mounting	7
2.2 Wire the hardware	8
2.2.1 Wire the controllers	8
2.2.2 Wire the communication	8
2.2.3 Wire the power supplies	9

3. Using the display unit

3.1 Display unit overview	10
----------------------------------	-----------

4. Getting started

4.1 Initial configuration	13
4.1.1 Pair to the controller	13
4.1.2 Configure the controller ID	13
4.2 PICUS	14
4.2.1 Download and install	14
4.2.2 First time log on	14
4.3 Application configuration	16
4.3.1 Create the single-line diagram	16
4.3.2 Configure the inputs and outputs	17
4.3.3 Configure the parameters	18

1. Introduction

1.1 About the quick start guide

1.1.1 General purpose

This is the quick start guide for DEIF's Paralleling and Protection Unit controller, PPU 300. The guide provides the basic information to install and configure the PPU 300 controllers.



Refer to the **Designer's handbook**, **Installation instructions**, **Commissioning guidelines**, **Operator's manual** and **PICUS manual** for more information.

1.1.2 Software versions

The information in this document corresponds to the following software versions.

Table 1.1 Software versions

Software	Details	Version
PCM APPL	Controller application	1.0.3.x
DU APPL	Display unit application	1.0.8.x
PICUS	PC software	1.0.7.x

1.2 Warnings and safety

1.2.1 Safety during installation and operation

Installing and operating the equipment may require work with dangerous currents and voltages. The installation must only be carried out by authorised personnel who understand the risks involved in working with electrical equipment.



DANGER!

Hazardous live currents and voltages. Do not touch any terminals, especially the AC measurement inputs and the relay terminals. Touching the terminals could lead to injury or death.

1.2.2 Controller power supply

The controller must have a reliable power supply, which must include a backup power supply. In addition, the switchboard design must ensure that the system is sufficiently protected if the controller power supply fails.

If the controller has no power supply, it is OFF and does **not** provide any protection. The controller cannot enforce any trips, shutdowns or latches when it is off. The controller does not provide any control or load sharing. All the controller relays de-energise.

1.2.3 Factory settings

The controller is delivered pre-programmed from the factory with a set of default settings. These settings are based on typical values and may not be correct for your system. You must therefore check all parameters before using the controller.

1.2.4 Reset to factory settings

The controller's I/O and parameter configuration is reset to the default factory settings if the controller type is changed in the single-line diagram.

1.2.5 Remote-controlled starts

The gensets can be started by remote signals (for example, by sending a Modbus signal, or using PICUS). To avoid personal injury, the genset design, the layout, and maintenance procedures must take this into account.

1.2.6 Electrostatic discharge

You must protect the equipment terminals from electrostatic discharge when not installed in a grounded rack. Electrostatic discharge can damage the terminals.

1.2.7 Data security

To minimise the risk of data security breaches DEIF recommends to:

- As far as possible, avoid exposing controllers and controller networks to public networks and the Internet.
- Use additional security layers like a VPN for remote access, and install firewall mechanisms.
- Restrict access to authorised persons.

1.3 Legal information

1.3.1 Trademarks

DEIF is a trademark of DEIF A/S.

CANopen® is a registered community trademark of CAN in Automation e.V. (CiA).

CODESYS® is a trademark of 3S-Smart Software Solutions GmbH.

EtherCAT® is a registered trademark and patented technology, licenced by Beckhoff Automation GmbH, Germany.

Modbus® is a registered trademark of Schneider Automation Inc.

Windows® is a registered trademark of Microsoft Corporation in the United States and other countries.

All trademarks are the properties of their respective owners.

1.3.2 Disclaimer

DEIF A/S reserves the right to change any of the contents of this document without prior notice.

The English version of this document always contains the most recent and up-to-date information about the product. DEIF does not take responsibility for the accuracy of translations, and translations might not be updated at the same time as the English document. If there is a discrepancy, the English version prevails.

1.3.3 Copyright

© Copyright DEIF A/S 2018. All rights reserved.

2. Installation and wiring

2.1 Mount the hardware

2.1.1 Controller mounting

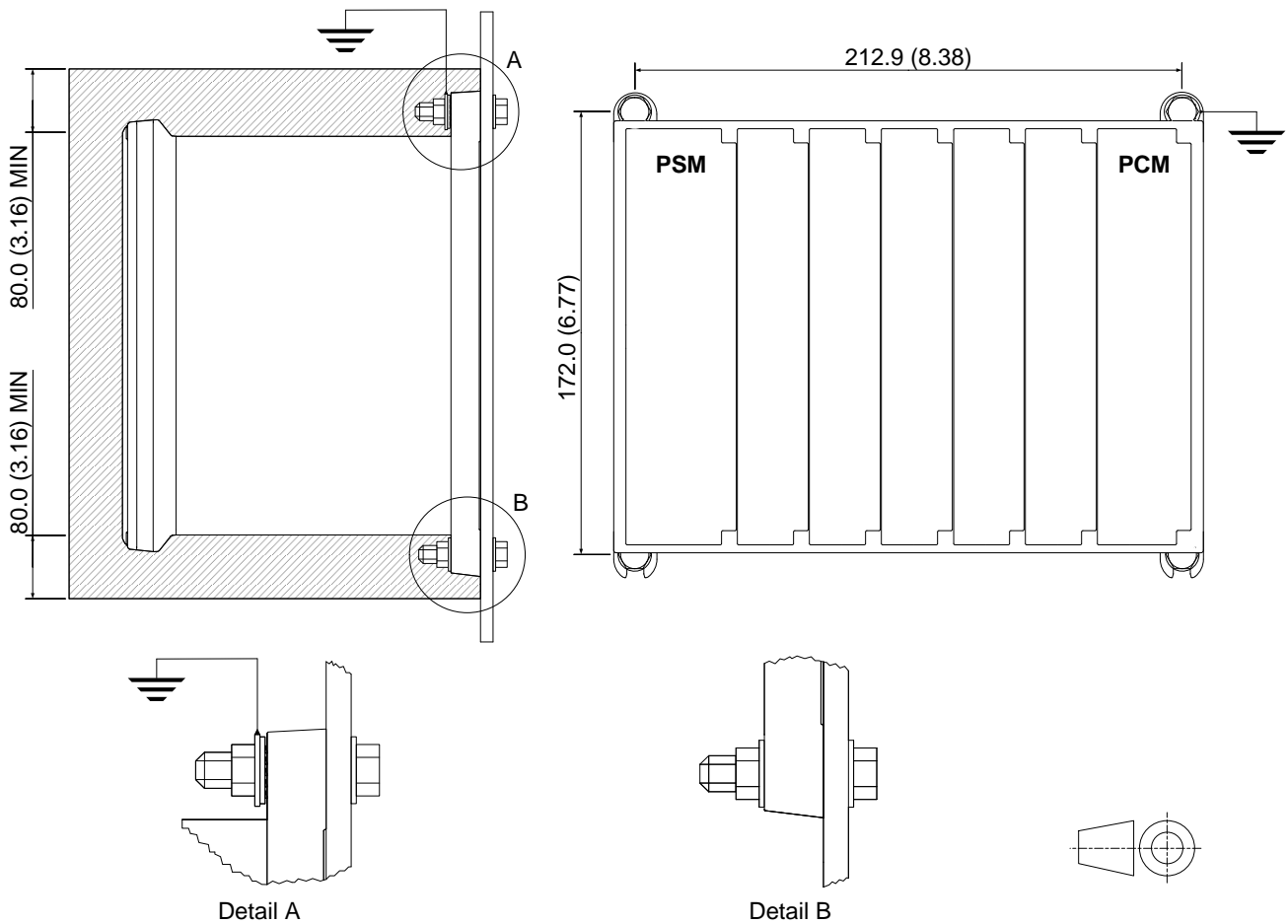

1. Check the available space at the vertical mounting position. There should be a minimum of 80 mm (3.16 inches) of free space above and below the controller for ventilation and cable installation.
2. Mount the rack at the mounting position with the PSM on the left and the PCM on the right when looking at the controller from the front.
3. One mounting position should be grounded. See *Detail A*.



INFO

The grounded position must have a toothed lock washer between the controller foot and the earth connection.

2.1.2 Display unit mounting

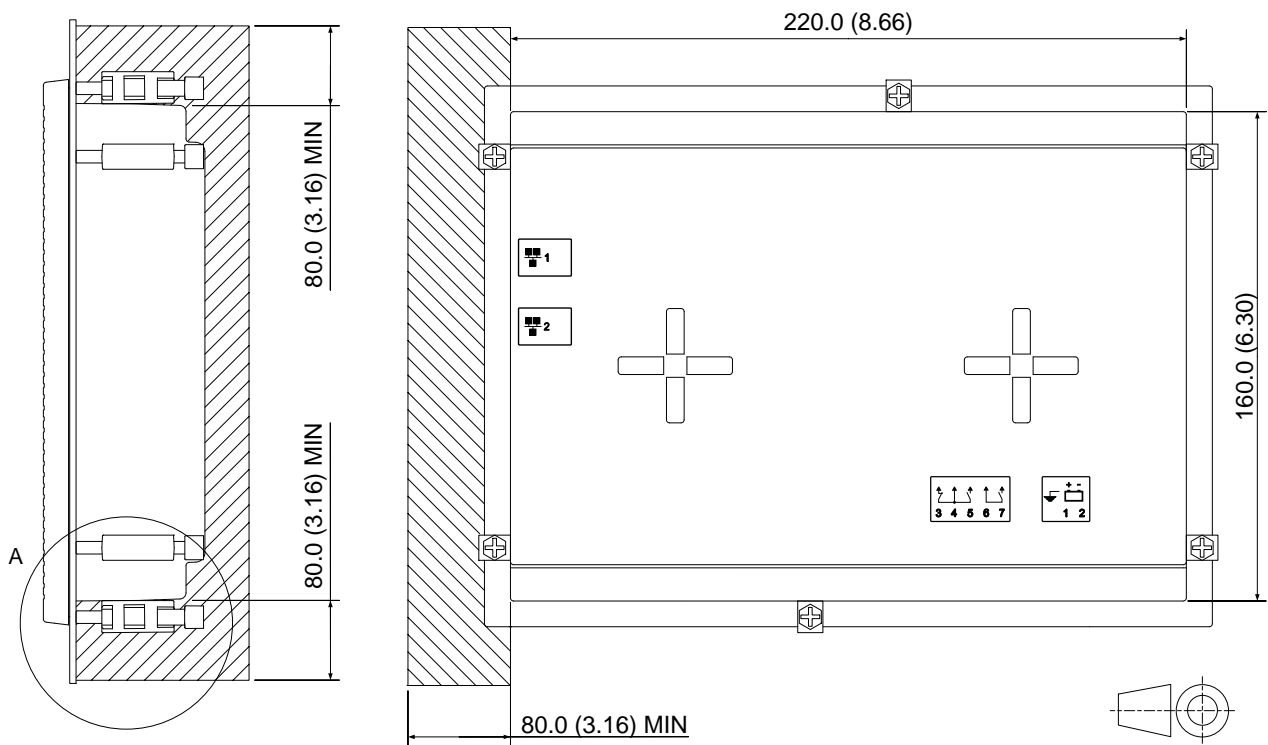

Detail A

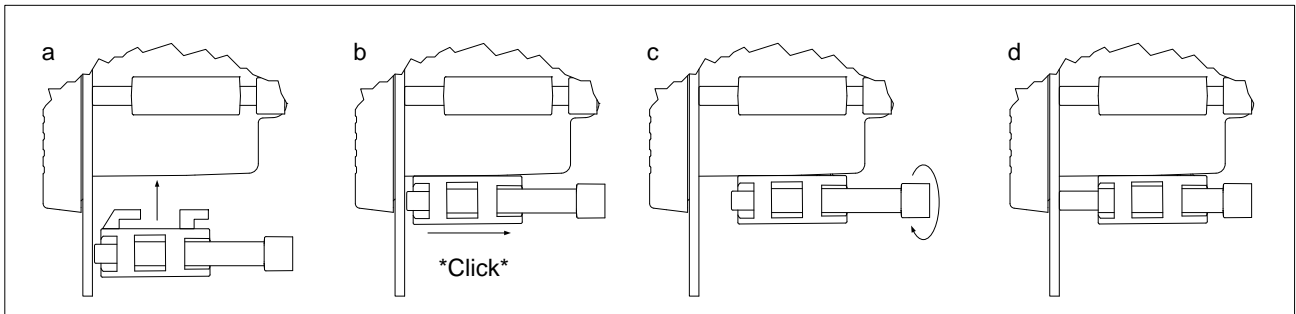

1. Check the available space at the vertical mounting position. There should be a minimum of 80 mm (3.16 inches) of free space above, below and to the left (seen from behind) of the display unit for ventilation and cable installation.
2. Slide the display unit into the mounting position.
3. Click in, and fasten the securing screws. See *Detail A*.

2.2 Wire the hardware

2.2.1 Wire the controllers

Connect the wires to the controller modules according to the system design.



CAUTION

Do NOT connect the power cables at this time.



Refer to the **Designer's handbook** and **Installation instructions** for more information.

2.2.2 Wire the communication

Figure 2.1 Example of how communication wires can be connected

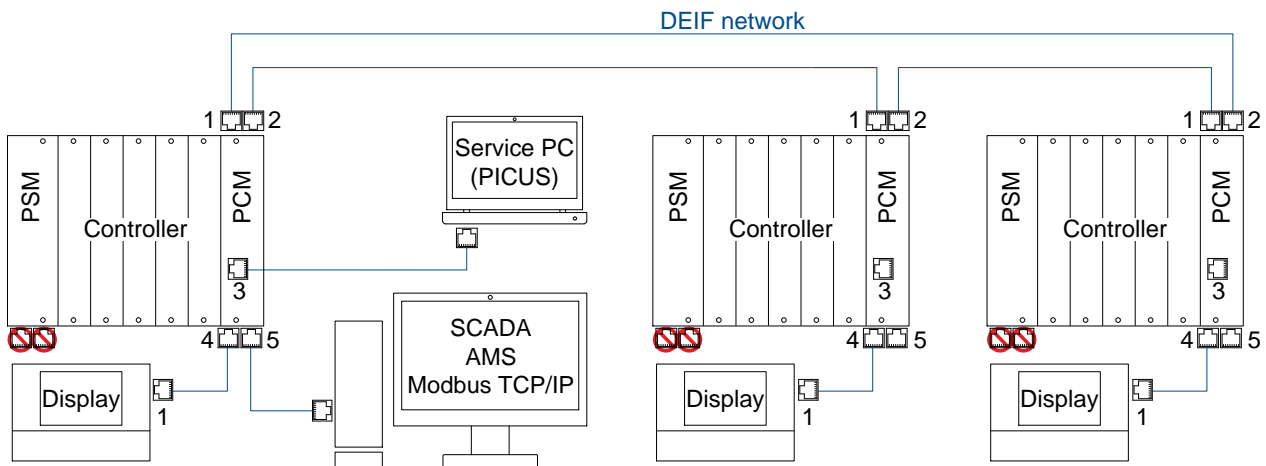

Connect the communication wires according to the system design.

- The diagram shows a wiring example for a Network ring.
- The diagram shows the recommended default connection for the Ethernet cables.
- The service PC, SCADA, alarm management system (AMS) and Modbus TCP/IP connections can be connected to any controller in the network.



Refer to the **Designer's handbook** and **Installation instructions** for information on configuring the system communication.

2.2.3 Wire the power supplies



CAUTION

Ensure the power supply is OFF before connecting the power supply to the controllers and display units.

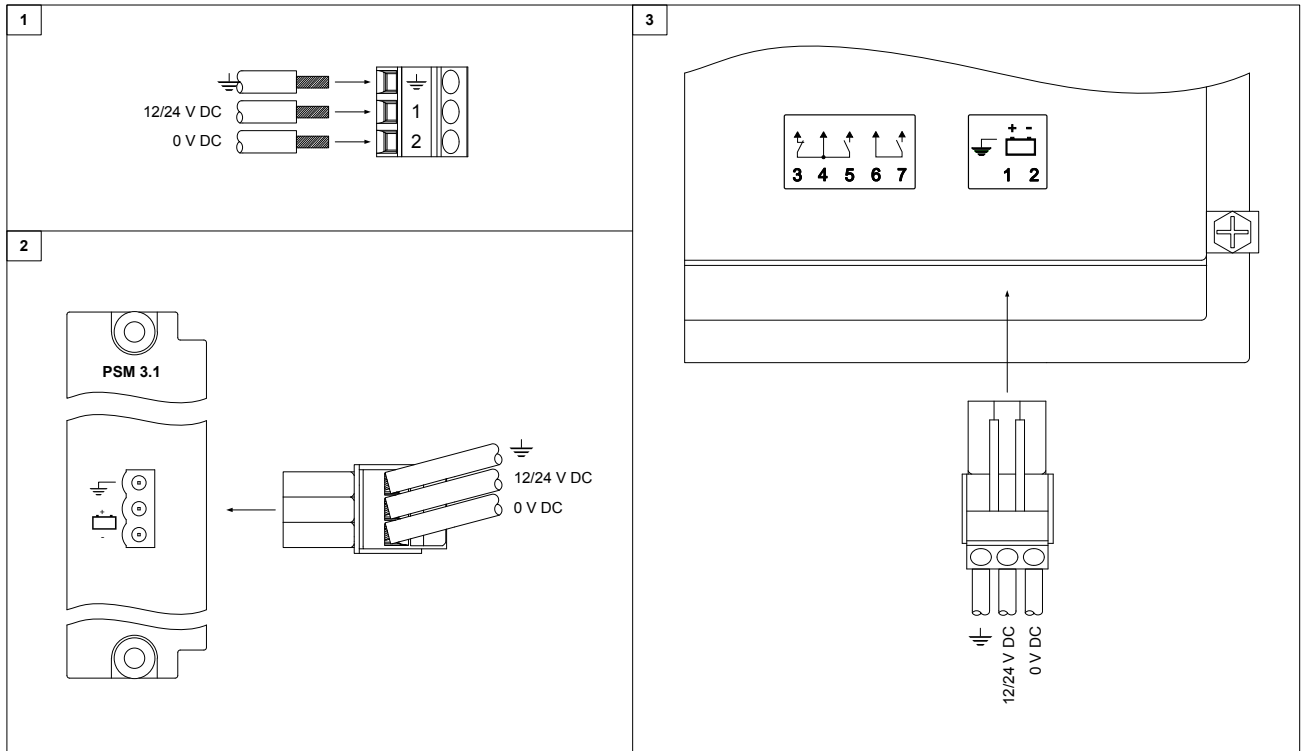

1. Connect the wires from the power supply to the power terminal blocks for the controllers and the display units.
2. Insert the power terminal blocks into the power terminals of the controllers' modules.
3. Insert the power terminal blocks into the power terminals of the display units.
4. Turn on the power.



3. Using the display unit

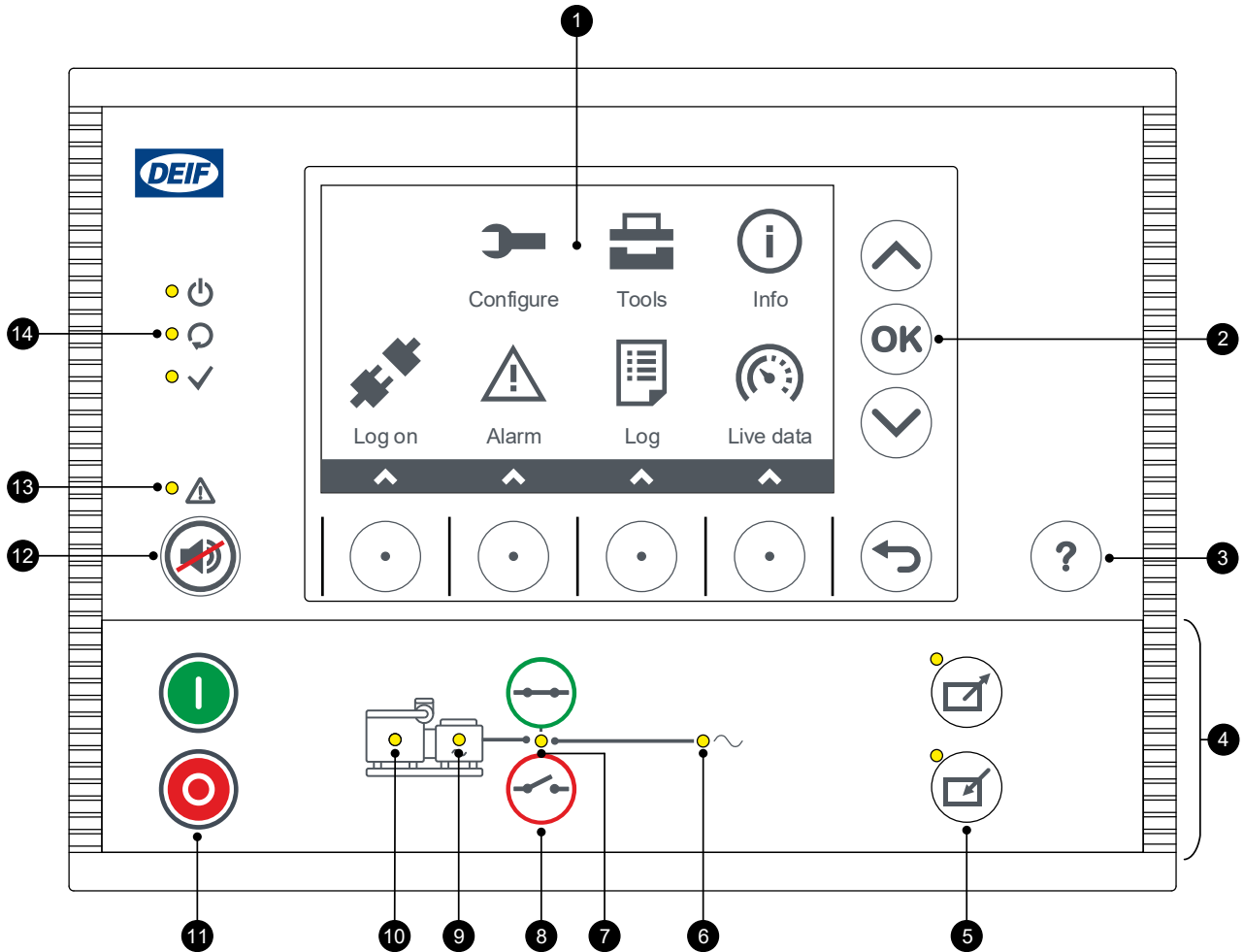

3.1 Display unit overview

Figure 3.1 Display unit for a GENSET controller, with full functionality folio (DG + CB CTRL)



Number	Name	Function
1	Screen	Displays the menus and status of the connected controller.
2	Navigation push buttons	Eight push buttons to navigate the menus and make configurations.
3	Help	Opens help for the screen that you are viewing.
4	Controller specific folio and push buttons	The layout, status LEDs and available push buttons can differ between controllers.
5	Mode selection push buttons	

Number	Name	Function
5	 REMOTE mode	The controller changes to REMOTE mode. When the controller is in REMOTE mode, commands can be sent from external control devices (for example, PLC or Modbus). Green LED: The controller is in REMOTE mode. OFF LED: The controller is not in REMOTE mode.
	 LOCAL mode	The controller changes to LOCAL mode. When the controller is in LOCAL mode, commands can be sent from the display unit. Green LED: The controller is in LOCAL mode. OFF LED: The controller is not in LOCAL mode.
6	Busbar LED	Green: The busbar voltage and frequency are OK, and the controller can synchronise and close the breaker. Green (flashing): The busbar voltage and frequency are OK, but the V&Hz OK timer is still running. The controller cannot close the breaker. Yellow: The busbar voltage and frequency are measurable, but not OK. Red: The busbar voltage is too low to measure (for example, during a blackout). The controller can close the breaker. Red (flashing): The blackout detection timer is running and the controller is checking the busbar.
7	Breaker LED	Green: The breaker is closed. Yellow: The breaker spring is charging (only applies to a compact breaker). Yellow (flashing): The controller is synchronising or de-loading the breaker. Red: The controller tripped the breaker, and the trip alarm is unacknowledged and/or the alarm condition is still present. Red (flashing): Any breaker trip alarm is active. OFF: The breaker is open.
8	Breaker close and open	Sends command to close or open the breaker in LOCAL mode.
9	Generator LED	Green: The generator voltage and frequency are OK, and the controller can synchronise and close the breaker. Green (flashing): The generator voltage and frequency are OK, but the V&Hz OK timer is still running. The controller cannot close the breaker. Yellow: The generator voltage and frequency are measurable, but not OK. The controller cannot close the breaker. OFF: The generator voltage is too low to measure.
10	Engine LED	Green: There is running feedback. Oil pressure, RPM, frequency above configured limit. Green (flashing): Engine is becoming ready. OFF: The engine is not running, or there is no running feedback.
11	Genset start and stop	Sends command to start or stop a genset in LOCAL mode.
12	Silence horn	Stops the horn output immediately.
13	Alarm LED	Red (constant): Alarm(s) active, and all alarms acknowledged. Red (flashing): Unacknowledged alarm(s). Yellow: Unlatched alarms can be reset (when no other alarms require action). Yellow (flashing): Unacknowledged latched alarms. Green (flashing): Only unacknowledged alarm(s) where the alarm condition has cleared. Green (constant): No alarms.
14	Controller status LEDs	
	 Display unit power OK	Green (constant): The display unit power is OK. OFF: The display unit power is not OK.

Number	Name	Function
14	 Self-check OK	<p>Green (constant) The controller self-check is OK. OFF: The controller self-check is not OK, or there is no connection to the controller.</p>
	 Ready for operation	<p>Green (constant): The controller is not under switchboard control, and there is no alarm action (for example, shutdown, trip or block) that prevents the source from supplying power. OFF: The controller is under switchboard control, or there is an alarm action that prevents the source from supplying power.</p>

4. Getting started

4.1 Initial configuration

4.1.1 Pair to the controller

The first time that a display unit is powered on, the operator must select a controller to pair with. Use **Configure > Pair** to change the pairing.

Figure 4.1 Example of the pair screen

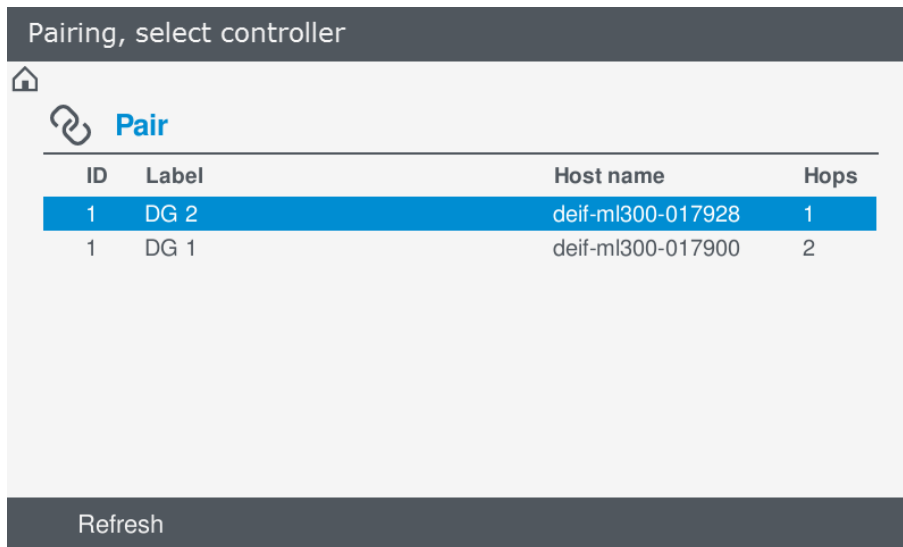

Pair to a controller

1. Highlight the controller you wish to pair with, by pressing **Up** or **Down** and select the controller by pressing **OK** .

INFO The number of hops shown indicate how close the controller may be to the display unit. 1 hop indicates the controller that the display unit is actually plugged in to.

2. Confirm the controller pairing by pressing **OK** . The display unit restarts automatically.

INFO If a display unit fails the controller can be paired with any display unit available in the network.

4.1.2 Configure the controller ID

The factory default *Controller ID* for a controller is 0 (zero). For each controller in the system, use the display unit to configure a unique *Controller ID*:

1. From the **Home** menu, select **Log on**.
2. Select the *Admin* user (default password: 00000004) and log on.

3. From the **Home** menu, select **Tools > Communication**.
4. Highlight *Controller ID*, and press **OK** to edit.
5. Use the virtual keyboard and **OK** to configure the *Controller ID* (the range is 1 to 64).
6. Select **Next**, and then select **Write** on the **Communication** screen.



Controller ID can also be configured using the PICUS software. Refer to the **PICUS manual** for more information.

4.2 PICUS

4.2.1 Download and install

Downloading PICUS

1. Visit: <http://www.deif.com/software>.
2. Scroll to **Software downloads** and choose **Multi-line 300 PICUS ver. 1.x.x.** software.
3. Submit your email address to receive a download link.
4. Follow the link to download PICUS.

Installing PICUS

1. Launch the PICUS installer from your computer.
2. Follow the instructions in the installer program.



See the **PICUS manual** for further information on how to download and install PICUS.



CAUTION

You must install *Bonjour*, if you do not already have this installed on your computer. This service is used for the network detection on the DEIF network. PICUS uses Bonjour to detect all controllers that are connected to the same network. No additional configuration is required.

4.2.2 First time log on

Logon

1. Use an Ethernet cable to connect your computer to a free Ethernet port (PCM port 3) on any controller in the system.

2. Launch PICUS  from the installed folder.

3. Select all the controllers from the list and select the **Connect**  icon at the bottom right.
4. Select the *Admin* user (default password: 00000004) from the available list.
5. Log on using the default password.

Change the administrator password

1. Go to **Tools > Advanced > Permissions > Users**.

2. Select the *Admin* user and select **Edit** .

3. Confirm the *Old password*, then enter and confirm the *New password*. Select **Save** .

4. To change the password of the controller that PICUS is logged on to, select **Write**  from the right side panel.

5. To change the password for all the other controllers that PICUS is connected to, select **Broadcast**  from the right side panel. Select all the controllers and select *OK*.

Change the date and time

For each controller:

1. Use PICUS to log on to the controller.

2. Go to **Tools > Date and time**.

3. Enter the correct date and time.

4. Select **Write**  from the right side panel.

4.3 Application configuration

4.3.1 Create the single-line diagram

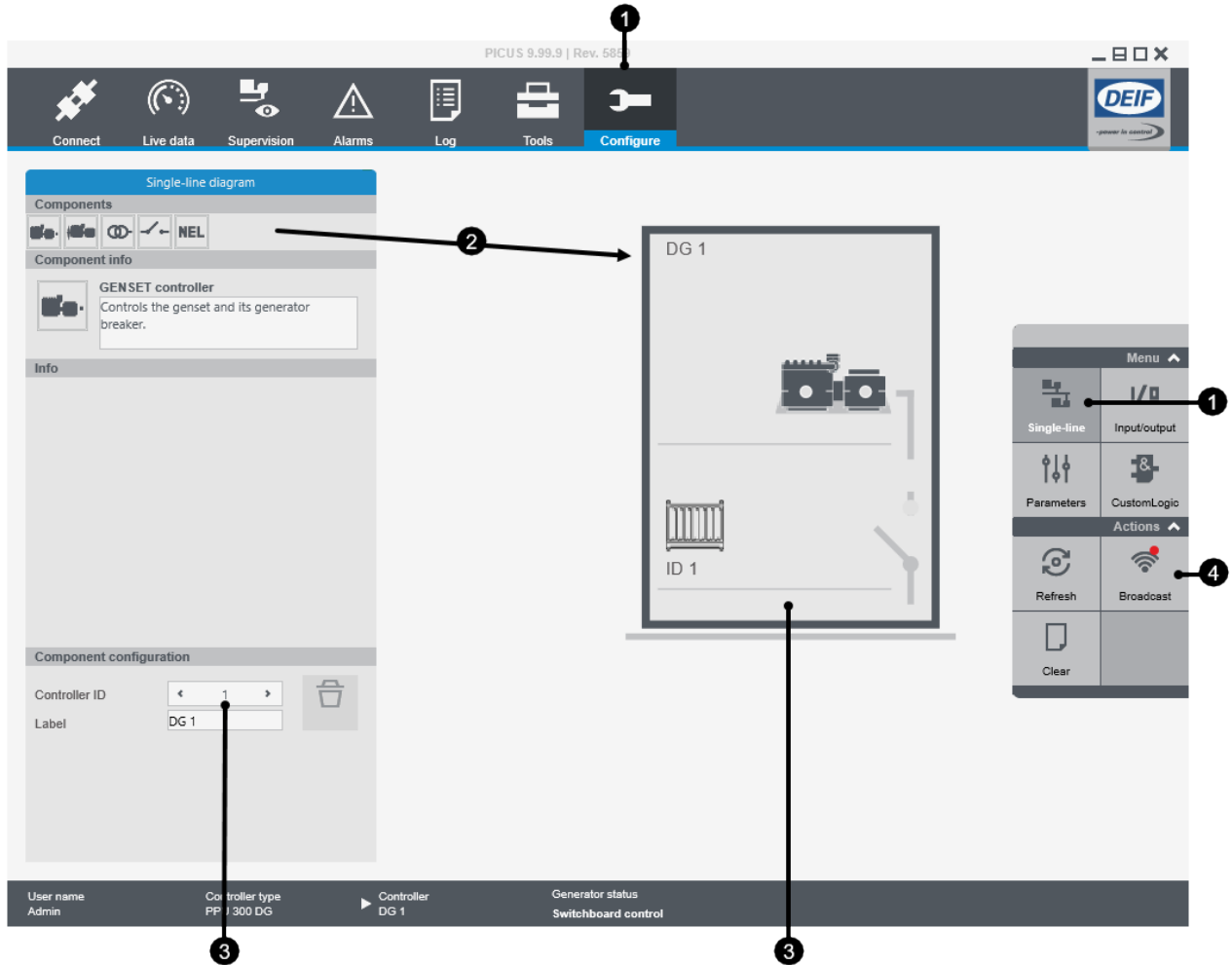

1. Go to **Configure > Single-line**.
2. Create the system single-line diagram by dragging components to the single-line area.
3. For each controller: Select the correct *Controller ID* under *Component configuration*.
4. Select **Broadcast**  from the right side panel. Select all the controllers and select **OK**.
 - If required, override the controller(s) status by selecting the override box.

Override controller(s) ready status and force broadcast.
 OK
Cancel



DANGER!
Do not override controller(s) status on a live system.





CAUTION

Changing controller type in the single-line diagram will reset I/O and parameter configuration to default factory settings.

4.3.2 Configure the inputs and outputs

IOM3.1, Slot 3			
State/Value	Terminal(s)	Name	Type
False	1, 2, 3	GB close	DO
True	4, 5, 6	GB open	DO
False	7, 8, 9	IOM out 3	DO
False	10, 11, 12	IOM out 4	DO
True	13, 23	GB open	DI
False	14, 23	GB closed	DI
False	15, 23	GB short circuit	DI
False	16, 23	Acknowledge all alarms	DI
False	17, 23	GB close	DI
False	18, 23	GB open	DI
False	19, 23	Activate inhibit 1	DI
False	20, 23	IOM in 8	DI

1. Go to **Configure > Input/output**.
2. Select the controller module to configure.
3. Select the terminal to configure.
4. Configure the terminal and select **Save**  when the configuration is complete.
 - Some I/Os must be configured in more than one page. For example, for analogue outputs first configure the function on the *Function* page, then configure the output on the *Output setup* page.
5. Repeat step 3 and step 4 for the remaining terminal configurations.
6. Select **Write**  from the right side panel.



INFO

You only configure the controller that you are *Logged on* and *Connected* to.

4.3.3 Configure the parameters

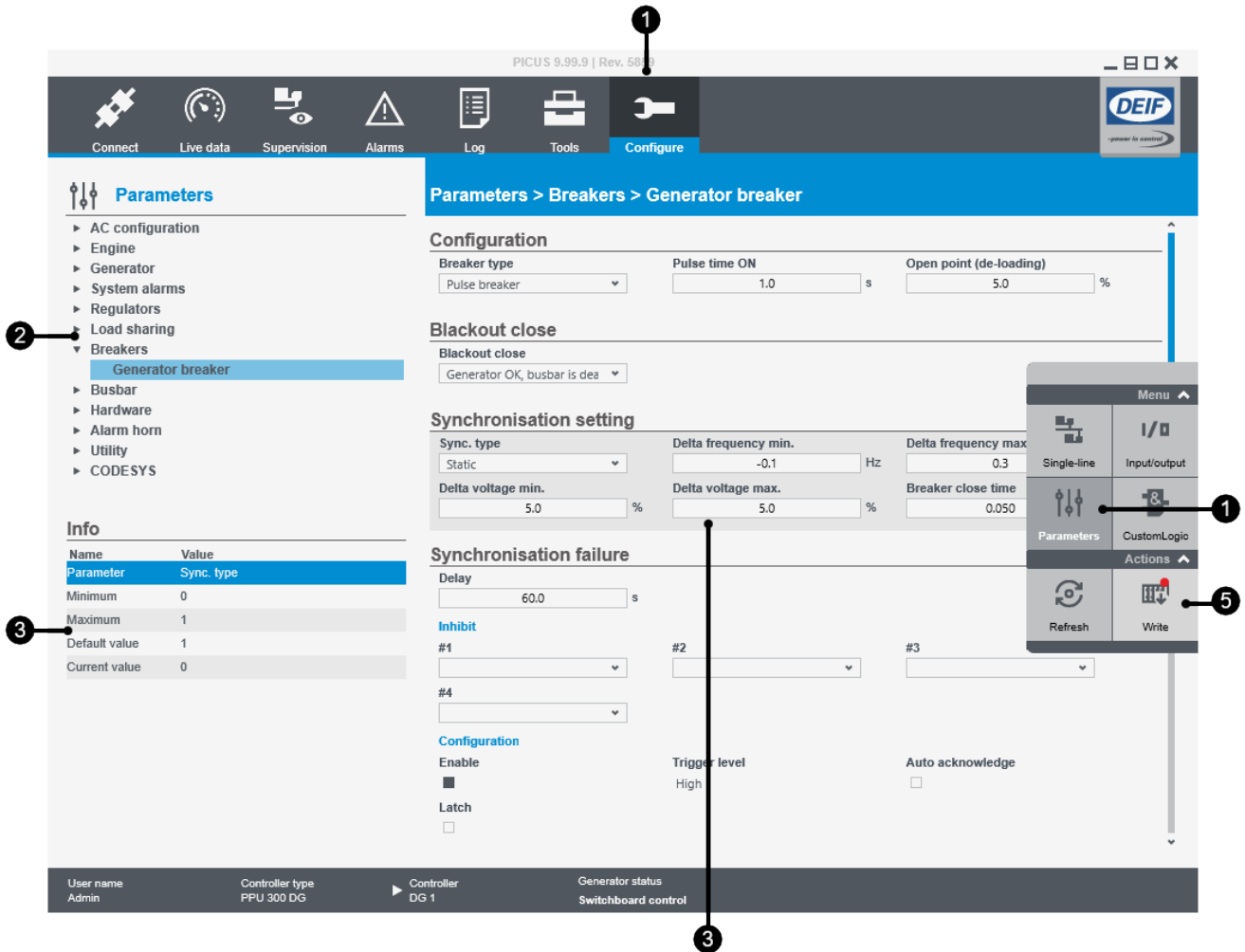

1. Go to **Configure > Parameters**.
2. Select the parameter group that you want to configure from the list.
3. Select and configure the parameter. Additional information about the parameter that you are configuring is displayed under *Info*.
4. Repeat step 2 and step 3 for the remaining parameters.
5. Select **Write**  from the right side panel.



INFO

You only configure the controller that you are *Logged on* and *Connected* to.