



-power in control



MULTI-LINE 2



GENERAL GUIDELINES FOR COMMISSIONING

- Settings check
- Governor check
- AVR check
- Protections check
- Adjustment
- Troubleshooting



DEIF A/S · Frisenborgvej 33 · DK-7800 Skive
Tel.: +45 9614 9614 · Fax: +45 9614 9615
info@deif.com · www.deif.com

Document no.: 4189340703C
SW version:

1. Delimitation

1.1. Scope of General guidelines for commissioning.....	4
1.1.1. Scope of document.....	4

2. General information

2.1. Warnings, legal information and safety.....	5
2.1.1. Warnings and notes	5
2.1.2. Legal information and disclaimer	5
2.1.3. Safety issues	5
2.1.4. Electrostatic discharge awareness	5
2.1.5. Factory settings	6
2.2. About the guidelines.....	6
2.2.1. General purpose.....	6
2.2.2. Intended users.....	6
2.2.3. Contents and overall structure	6

3. Commissioning of the Multi-line 2

3.1. Step by step.....	7
3.1.1. Step by step.....	7

4. Settings

4.1. Settings check.....	8
4.1.1. Settings.....	8
4.1.2. Nominal values.....	8
4.1.3. Alarm settings.....	9
4.1.4. Function control settings.....	10
4.1.5. Synchronisation settings.....	11
4.1.6. Speed controller settings.....	11
4.1.7. Voltage controller settings.....	12

5. Governor check

5.1. Instructions.....	13
5.1.1. Instructions	13
5.2. Speed setting.....	13
5.2.1. Speed setting.....	13
5.2.2. Relay output.....	13
5.2.3. Analogue output.....	13
5.2.4. EIC, J1939	13
5.3. Speed droop.....	14
5.3.1. Speed droop.....	14
5.4. Speed range.....	14
5.4.1. Speed range.....	14
5.5. Terminals.....	14
5.5.1. Terminals.....	14
5.5.2. Digital interfacing.....	14
5.5.3. Analogue interfacing.....	15
5.5.4. EIC, J1939	15

6. AVR check

6.1. Instructions.....	17
6.1.1. Instructions.....	17
6.2. Voltage setting.....	17
6.2.1. Voltage setting.....	17
6.2.2. Relay output.....	17
6.2.3. Analogue output.....	17
6.3. Voltage droop.....	17
6.3.1. Voltage droop.....	17
6.4. Voltage range.....	18

6.4.1. Voltage range.....	18
6.5. Terminals.....	18
6.5.1. Terminals.....	18
7. Protections	
7.1. Protections check.....	19
7.1.1. Points to be considered.....	19
7.1.2. Considerations.....	19
7.1.3. Configuration of the protections.....	19
8. Adjustment	
8.1. Adjustment overview.....	21
8.1.1. Overview.....	21
8.2. Adjusting PID controller.....	21
8.2.1. PID controller.....	21
8.2.2. Step 1, adjustment of the KP.....	21
8.2.3. Step 2, adjustment of the Ti.....	21
8.2.4. Step 3, adjustment of the Td.....	21
8.2.5. Step 4, readjustment of controller settings.....	22
8.2.6. Manual governor and AVR control.....	22
8.2.7. Manual mode/switchboard control.....	22
8.2.8. Semi-auto mode (AGC 200/AGC-3/AGC-4 only).....	22
8.2.9. Auto and test mode (AGC 200/AGC-3/AGC-4 only).....	23
8.3. Relay output adjustments.....	23
8.3.1. Relay output adjustments.....	23
8.4. Resulting speed/voltage curve upon load change.....	23
8.4.1. Resulting speed/voltage curve upon load change.....	23
9. Troubleshooting	
9.1. Troubleshooting for Multi-line 2 and Uni-line products.....	25
9.1.1. Remedy of problem.....	25

1. Delimitation

1.1 Scope of General guidelines for commissioning

1.1.1 Scope of document

This document covers the following products:

AGC 200 series	SW version 3.5x.x or later
AGC-3	SW version 3.3x.x or later
AGC-4	SW version 4.0x.x or later
GPC-3/GPU-3 Hydro	SW version 3.0x.x or later
AGC PM	SW version 5.03.x or later
GPU-3/PPU-3	SW version 3.0x.x or later
PPM-3	SW version 3.0x.x or later

2. General information

2.1 Warnings, legal information and safety

2.1.1 Warnings and notes

Throughout this document, a number of warnings and notes with helpful user information will be presented. To ensure that these are noticed, they will be highlighted as follows in order to separate them from the general text.

Warnings



Warnings indicate a potentially dangerous situation, which could result in death, personal injury or damaged equipment, if certain guidelines are not followed.

Notes



Notes provide general information, which will be helpful for the reader to bear in mind.

2.1.2 Legal information and disclaimer

DEIF takes no responsibility for installation or operation of the generator set. If there is any doubt about how to install or operate the engine/generator controlled by the Multi-line 2 unit, the company responsible for the installation or the operation of the set must be contacted.



The Multi-line 2 unit is not to be opened by unauthorised personnel. If opened anyway, the warranty will be lost.

Disclaimer

DEIF A/S reserves the right to change any of the contents of this document without prior notice.

The English version of this document always contains the most recent and up-to-date information about the product. DEIF does not take responsibility for the accuracy of translations, and translations might not be updated at the same time as the English document. If there is a discrepancy, the English version prevails.

2.1.3 Safety issues

Installing and operating the Multi-line 2 unit may imply work with dangerous currents and voltages. Therefore, the installation should only be carried out by authorised personnel who understand the risks involved in working with live electrical equipment.



Be aware of the hazardous live currents and voltages. Do not touch any AC measurement inputs as this could lead to injury or death.

2.1.4 Electrostatic discharge awareness

Sufficient care must be taken to protect the terminals against static discharges during the installation. Once the unit is installed and connected, these precautions are no longer necessary.

2.1.5 Factory settings

The Multi-line 2 unit is delivered from factory with certain factory settings. These are based on average values and are not necessarily the correct settings for matching the engine/generator set in question. Precautions must be taken to check the settings before running the engine/generator set.

2.2 About the guidelines

2.2.1 General purpose

This document includes general guidelines for commissioning of DEIF's Multi-line 2 units. It mainly includes instructions for settings, governor, AVR and protections check and unit adjustment. The general purpose of the document is to supply general guidelines to be used in the commissioning of the Multi-line 2.



Please make sure to read this document before starting to work with the Multi-line 2 unit and the genset to be controlled. Failure to do this could result in human injury or damage to the equipment.

2.2.2 Intended users

These guidelines are mainly intended for the person responsible for the commissioning of the unit. In most cases, this would be a commissioning engineer.

2.2.3 Contents and overall structure

This document is divided into chapters, and in order to make the structure simple and easy to use, each chapter will begin from the top of a new page.

3. Commissioning of the Multi-line 2

3.1 Step by step

3.1.1 Step by step

The illustration below indicates the overall steps to be followed in order to carry out a successful commissioning of the Multi-line 2 unit.

Step 1	Settings check
Step 2	Governor check
Step 3	AVR check
Step 4	Protections check
Step 5	Adjustment

In addition, the generic troubleshooting in the chapter "Troubleshooting" can be used.

4. Settings

4.1 Settings check

4.1.1 Settings

It is necessary to perform a settings check. This is done by following these five individual steps:

1. Check and adjust the nominal settings.
2. Check and adjust the alarm settings.
3. Check and adjust the function control settings.
4. Check and adjust the speed controller settings.
5. Check and adjust the voltage controller settings.

The above-mentioned settings must be checked and adjusted prior to the initial starting of the genset.

 The settings can be adjusted either through the display or through the PC utility software. For navigating in the menus, see the Operator's Manual.

4.1.2 Nominal values

The nominal values of the Multi-line 2 are adjusted in the general part of the system setup menu.

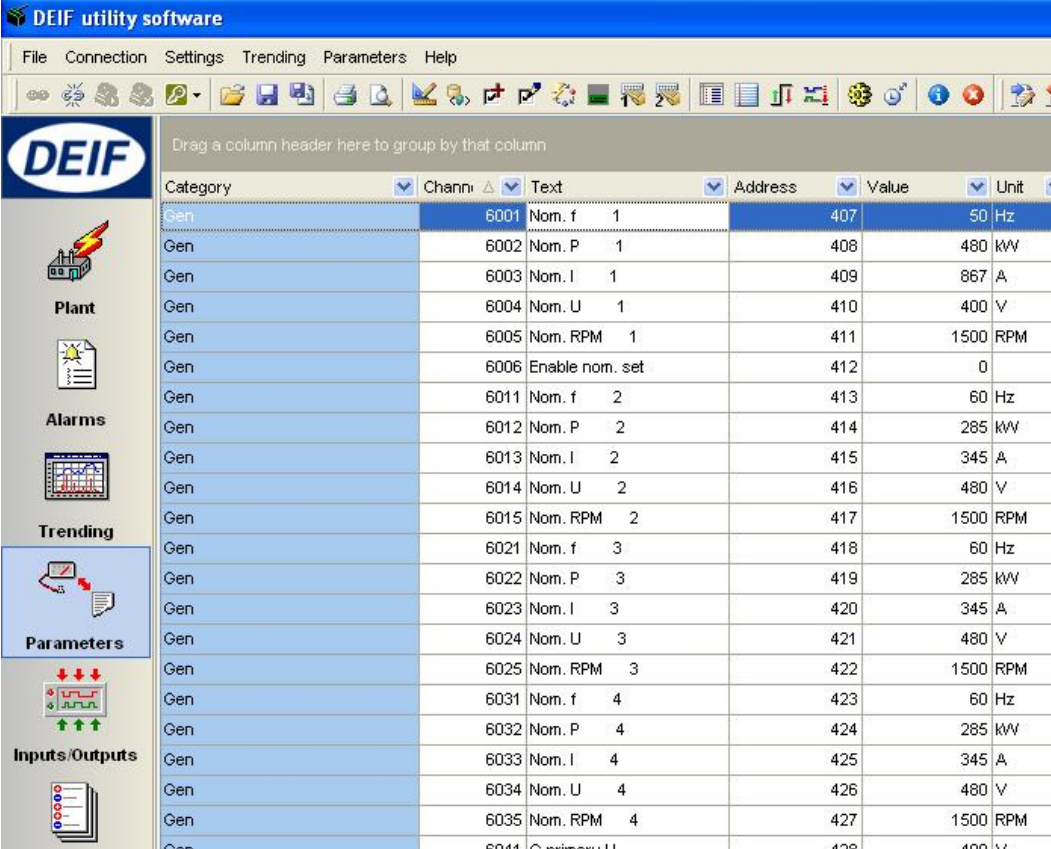

The screenshot shows the DEIF utility software interface. The main window displays a table of nominal values for various parameters. The table has columns for Category, Chann, Text, Address, Value, and Unit. The parameters are listed in the table below:

Category	Chann	Text	Address	Value	Unit
Gen	6001	Nom. f 1	407	50	Hz
Gen	6002	Nom. P 1	408	480	kW
Gen	6003	Nom. I 1	409	867	A
Gen	6004	Nom. U 1	410	400	V
Gen	6005	Nom. RPM 1	411	1500	RPM
Gen	6006	Enable nom. set	412	0	
Gen	6011	Nom. f 2	413	60	Hz
Gen	6012	Nom. P 2	414	285	kW
Gen	6013	Nom. I 2	415	345	A
Gen	6014	Nom. U 2	416	480	V
Gen	6015	Nom. RPM 2	417	1500	RPM
Gen	6021	Nom. f 3	418	60	Hz
Gen	6022	Nom. P 3	419	285	kW
Gen	6023	Nom. I 3	420	345	A
Gen	6024	Nom. U 3	421	480	V
Gen	6025	Nom. RPM 3	422	1500	RPM
Gen	6031	Nom. f 4	423	60	Hz
Gen	6032	Nom. P 4	424	285	kW
Gen	6033	Nom. I 4	425	345	A
Gen	6034	Nom. U 4	426	480	V
Gen	6035	Nom. RPM 4	427	1500	RPM
Gen	6041	Gen primary U	428	400	V

In the PC utility software, it is presented as illustrated on the above screen dump. The correct values are supplied by the switchboard manufacturer.

4.1.3 Alarm settings

The alarm settings are adjusted in the protection setup menu.

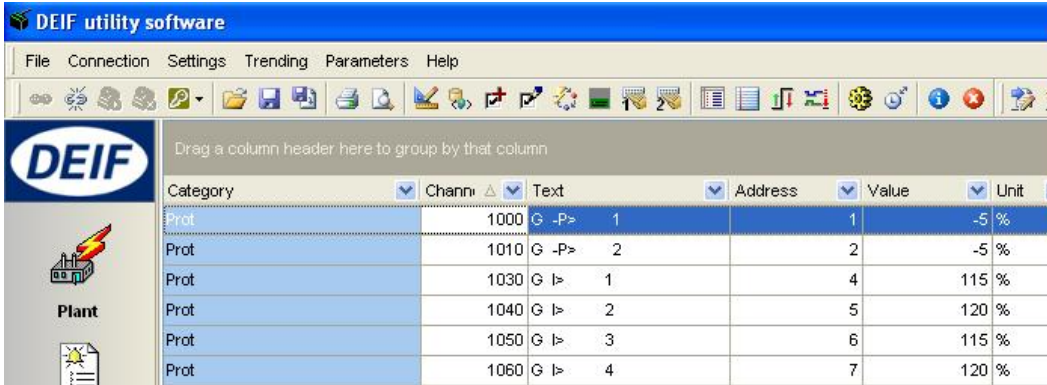

The screenshot shows the DEIF utility software interface. The title bar reads "DEIF utility software". The menu bar includes "File", "Connection", "Settings", "Trending", "Parameters", and "Help". The toolbar contains various icons for file operations and data visualization. The main window displays a table of alarm settings. The table has columns for "Category", "Chann", "Text", "Address", "Value", and "Unit". The "Category" column contains "Prot" for all rows. The "Chann" column contains values 1000, 1010, 1030, 1040, 1050, and 1060. The "Text" column contains "G -P>", "G -P>", "G I>", "G I>", "G I>", and "G I>". The "Address" column contains values 1, 2, 4, 5, 6, and 7. The "Value" column contains values 1, 2, 4, 5, 6, and 7. The "Unit" column contains values "-5 %", "-5 %", "115 %", "120 %", "115 %", and "120 %".

Category	Chann	Text	Address	Value	Unit
Prot	1000	G -P> 1		1	-5 %
Prot	1010	G -P> 2		2	-5 %
Prot	1030	G I> 1		4	115 %
Prot	1040	G I> 2		5	120 %
Prot	1050	G I> 3		6	115 %
Prot	1060	G I> 4		7	120 %

In the PC utility software, it is presented as illustrated on the screen dump above or similar. The number of alarms depends on the options selection of the individual unit. The actual alarm parameters are adjusted according to customer requirements and application requirements.

4.1.4 Function control settings

The function control settings are adjusted in the general part of the system setup menu.

The screenshot shows the DEIF utility software interface. The main window displays a table of function control settings. The table has columns for Category, Chann, Text, Address, Value, and Unit. The 'Parameters' menu item is highlighted in the left sidebar.

Category	Chann	Text	Address	Value	Unit
Gen	6130	Alarm horn	449	N/A	s
Gen	6160	Run status	452	N/A	
Gen	6171	Number of teeth	453	0	
Gen	6172	Run detect type	454	2	
Gen	6173	Running detect.	455	1000	
Gen	6174	Remove starter	456	400	
Gen	6181	Start Prepare	458	N/A	
Gen	6182	Ext. Start Prepare	459	N/A	
Gen	6183	Start On Time	460	N/A	
Gen	6184	Start Off Time	461	N/A	
Gen	6190	Start attempts	462	3	
Gen	6201	Shutdown overr.	463	7	
Gen	6202	Shutdown overr.	464	N/A	
Gen	6203	Shutdown overr.	465	N/A	
Gen	6211	Cooldown Time	466	N/A	
Gen	6212	Extended Stop Time	467	N/A	

In the screen dump above, only some of the settings are illustrated. Since the function control settings include parameters for the entire functionality of the Multi-line 2, they must be stepped through carefully. The function control settings are adjusted according to the desired unit control.



In need of detailed information about the requirements, contact the switchboard manufacturer.

4.1.5 Synchronisation settings

The ML-2 synchronisation settings are adjusted in the synchronisation part of the control setup menu.

Category	Chann	Text	Address	Value	Unit
Sync	2022	Sync. dfMin	66	0	Hz
Sync	2023	Sync. dUMax	67	5	%
Sync	2024	Sync. t GB	68	50	ms
Sync	2025	Sync. t MB	69	50	ms
Sync	2031	Maximum df	70	0,1	Hz
Sync	2032	Maximum dU	71	5	%
Sync	2033	Closing window	72	10	deg
Sync	2034	Static sync	73	N/A	s
Sync	2041	f sync. Kp	74	0,5	

i GPU/GPU Hydro: synchronisation requires option G2.

4.1.6 Speed controller settings

The Multi-line 2 speed controller settings are adjusted in the regulation part of the control setup menu.

The screendump below illustrates the controller settings related to the speed governor. As an initial setting before the first start up, the K_p of the frequency and power controllers are set to a low value giving a slow regulation.

Category	Chann	Text	Address	Value	Unit
Reg	2560	GOV reg. fail	134	30	%
Reg	2571	f deadband	135	1	%
Reg	2572	f Kp relay	136	10	
Reg	2581	P deadband	137	2	%
Reg	2582	P Kp relay	138	10	
Reg	2591	P LS f deadband	139	1	%
Reg	2592	P ls. f Kp rel.	140	10	
Reg	2593	P LS P deadband	141	2	%
Reg	2594	P LS P weight	142	10	%
Reg	2601	GOV ON time	143	500	ms
Reg	2602	GOV period time	144	2500	ms

Analogue controller or EIC, J1939

As an initial setting before the first start up, the K_p , T_i and T_d of the frequency and power controllers are set to a value giving a slow regulation. This means that K_p and T_d should be set to a low value, and T_i should be set to a high value.

4.1.7 Voltage controller settings

The voltage controller settings are adjusted in the regulation part of the control setup menu.

Category	Chann	Text	Address	Value	Unit
Reg	2680	AVR reg. fail	162	30	%
Reg	2691	U deadband	163	2	%
Reg	2692	U Kp relay	164	10	
Reg	2701	Q deadband	165	2	%
Reg	2702	Q Kp relay	166	10	
Reg	2711	Q LS U deadband	167	1	%
Reg	2712	Q Is. U Kp rel.	168	10	
Reg	2713	Q LS Q deadband	169	2	%
Reg	2714	Q LS Q weight	170	100	
Reg	2721	AVR ON time	171	100	ms
Reg	2722	AVR period time	172	500	ms

The screendump above illustrates the controller settings of the voltage and reactive power controller. As an initial setting before the first start up, the K_p of the voltage and reactive power controllers are set to a low value giving a slow regulation.

Analogue controller or J1939

As an initial setting before the first start up, the K_p , T_i and T_d of the frequency and power controllers are set to a value giving a slow regulation. This means that K_p and T_d should be set to a low value, and T_i should be set to a high value.

5. Governor check

5.1 Instructions

5.1.1 Instructions

Even if the engine manufacturer has adjusted the governor, it is necessary to carry out the following adjustments to be sure that the Multi-line 2 can successfully operate with the speed governor.

The governor should be tuned in according to the governor/engine manufacturer's instructions. It is important that the engine is able to run smoothly and without hunting, before the control function of the Multi-line 2 is activated.

5.2 Speed setting

5.2.1 Speed setting

An initial speed setting must be made.



The speed setting procedure is depending on the interfacing.

5.2.2 Relay output

- Disable the outputs from the Multi-line 2.
- Run the generator with no load (open generator breaker).
- Adjust the frequency (on the speed governor) to be base frequency (50 or 60 Hz).

5.2.3 Analogue output

The analogue output is a +/-25 mA or 0-20 mA (depending on option) signal which in most cases must be converted into a voltage using a resistor across the terminals (150 Ω gives 3V DC at 20 mA, etc).

The AGC 200 series has no analogue outputs. If analogue outputs are needed, the IOM 200 series external interface unit must be used.

Given the fact that especially the governors are sensitive to the external circuit impedance, it is essential to carry out the initial setting of speed governor while the Multi-line 2 is connected and the control function disabled.

Putting the Multi-line 2 in manual operation, (AGC 200/AGC-3/AGC-4 = MAN, PPM = switchboard control) disables the control function. This will "disable" the control outputs, but the generator protection is still active. If you fail to do this, you may experience control problems later on.

- Set the unit in manual operation/switchboard control.
- Reboot the unit or activate the input "reset analogue controller outputs".
- Run the generator with no load (open generator breaker).
- Set the frequency (on the speed governor) to be base frequency (50 or 60 Hz).

5.2.4 EIC, J1939

The speed setting is not possible to adjust because the proper rpm is adjusted in the ECU from the factory side.

5.3 Speed droop

5.3.1 Speed droop

The speed governor must have a speed droop of 3-4% (speed dropping 3-4% from no load to full load, when the Multi-line 2 is **not** in control). In order to ensure equal load sharing on parallel running machines, all governors must have the same droop setting.

DEIF recommends adjusting the speed droop on the speed governor for stability purposes.



It is necessary in all cases when relay outputs for governor control is used.

When analogue interfacing is used, it is possible to operate with a speed droop adjustment of 0%, but for safety reasons it is recommended to use the speed droop adjustment.

5.4 Speed range

5.4.1 Speed range

When using the analogue interfacing, the resistor installed across the output terminals is selected to obtain the necessary speed range. When finding the correct resistor, several aspects must be considered.

The necessary speed range must be selected, so it is possible to operate at full load. Typically, this is $f_{NOM} + 3$ Hz. If the speed range is too high, the resistor size must be decreased. If the speed range is too low, the resistor size must be increased.



The speed range must allow for the full load of the genset. If full load cannot be reached, then the resistor size must be increased.

5.5 Terminals

5.5.1 Terminals

The governor can either be prepared for analogue interfacing or digital interfacing. When analogue interfacing is used, a +/-25 mA or 0-20 mA signal from the Multi-line 2 is applied. This signal can be converted to the necessary voltage level. When digital interfacing is used, two relays are used as increase/decrease outputs.

The terminals must be identified depending on the necessary interfacing. Some general examples are shown in the following illustrations.

5.5.2 Digital interfacing

Motor potmeter

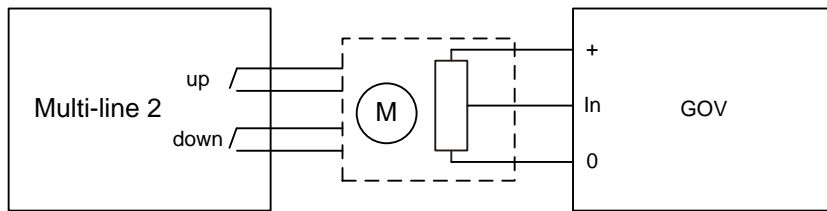

Direct digital signals

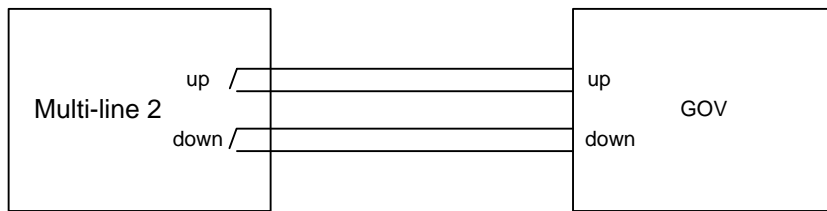

5.5.3 Analogue interfacing

Direct analogue signal

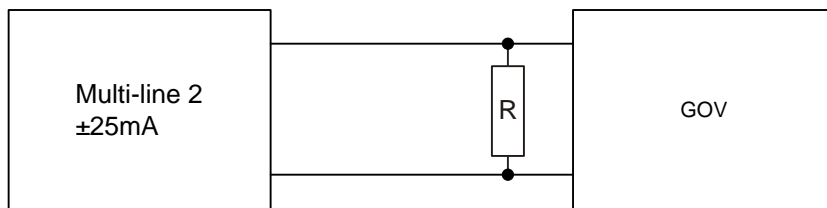

External potmeter

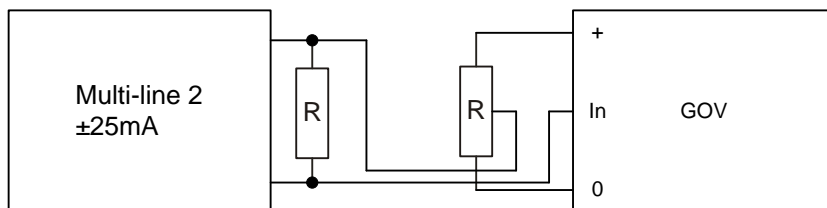

5.5.4 EIC, J1939

The interface is between CAN L and CAN H.

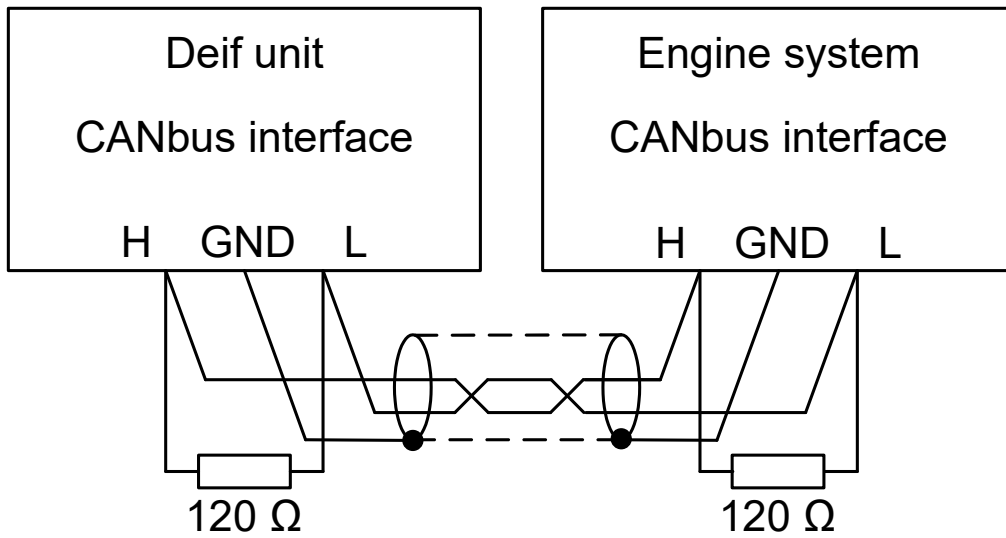

For additional information about interfaces, see the document "Interfacing DEIF Equipment, application notes 4189340670 UK" available on www.deif.com.

6. AVR check

6.1 Instructions

6.1.1 Instructions

Even if the AVR is adjusted by the genset manufacturer, it is necessary to go through the following adjustments in order to be sure that the Multi-line 2 can operate with the AVR.

The AVR should be tuned in according to the AVR/generator manufacturer's instructions. It is imperative that the genset is able to operate smoothly, before the control function of the Multi-line 2 is activated.

6.2 Voltage setting

6.2.1 Voltage setting

An initial voltage level setting must be made.



The voltage level setting procedure is depending on the interfacing.

6.2.2 Relay output

- Disable the outputs from the Multi-line 2.
- Run the generator with no load (open generator breaker).
- Adjust the voltage (on the AVR) to be nominal voltage.

6.2.3 Analogue output

The analogue output is a +/-25 mA or 0-20 mA (depending on option) signal which in most cases has to be converted into a voltage using a resistor across the terminals (150 Ω gives 3V DC at 20 mA etc).

The AGC 200 series has no analogue outputs. If analogue outputs are needed, the IOM 200 series external interface unit must be used.

Given the fact that especially the AVRs are sensitive to the external circuit impedance, it is essential to carry out the initial setting of the AVR while the Multi-line 2 is connected and the control function disabled.

Putting the Multi-line 2 in manual operation, (AGC 200/AGC-3/AGC-4 = MAN, PPM = switchboard control) disables the control function. This will 'disable' the control outputs, but the generator protection is still active. If you fail to do this, you may experience control problems later on.

- Set the unit in manual operation/switchboard control.
- Reboot the unit or activate the input "reset analogue controller outputs".
- Run the generator with no load (open generator breaker).
- Set the voltage (on the AVR) to be nominal voltage.

6.3 Voltage droop

6.3.1 Voltage droop

The AVR controls the generator voltage in a way which is comparable to the speed governor controlling the prime mover speed.

This means that the generator AVR must have a voltage droop of 3-4% (voltage dropping 3-4% from no load to full reactive load when the Multi-line 2 has no control). In order to ensure equal VAR sharing on parallel running generators, all generators must have the same voltage droop setting.

6.4 Voltage range

6.4.1 Voltage range

When using the analogue interfacing, the resistor installed across the output terminals is selected to obtain the necessary speed range. The voltage range must be defined similar to the speed range for the governor.

The voltage range must be wide enough for the voltage droop and for the full loading of the genset. A typical value is $\pm 10\% \cdot U_{\text{NOM}}$. The necessary control signal level is often specified depending on the AVR type.

6.5 Terminals

6.5.1 Terminals

The AVR can either be prepared for analogue interfacing or digital interfacing. When analogue interfacing is used, a ± 25 mA or 0-20 mA signal from the Multi-line 2 is applied. This signal can be converted to the necessary voltage level. When the digital interfacing is used, two relays are used as increase/decrease outputs.

The AGC 200 series has no analogue outputs. If analogue outputs are needed, the IOM 200 series external interface unit must be used.

The terminals must be identified depending on the necessary interfacing. Some general examples are shown in the illustrations in the chapter "Governor check".

7. Protections

7.1 Protections check

7.1.1 Points to be considered

As a part of the commissioning, the protections should be checked.

The following points must be considered for each alarm:

- Alarm setpoint
- Alarm delay
- Relay output
- Activation
- Fail class
- Inhibits



For further information about the above-mentioned, see the Designer's Reference Handbook.

7.1.2 Considerations

Several issues must be taken into consideration when doing the configuration of the alarms. These are e.g. national rules and requirements, additionally installed protection equipment, required use of the protections (trip of non-essential load, breaker tripping and engine stopping).

The switchboard manufacturer and the end customer must take these considerations.

7.1.3 Configuration of the protections

The dialogue box shows a typical alarm.

Parameter "G -P>" 1" (Channel 1000)

Setpoint : -50 -5 % 0

Timer : 0.1 10 sec 100,0

Fail class : Trip of CB

Output A : Not used

Output B : Not used

Password level : Customer

Enable High Alarm Inverse proportional Auto acknowledge Inhibits...

Commissioning

Actual value : 0 %

Time elapsed : 0 sec (0 %)

0 sec 10 sec

Write OK Cancel



In the "commissioning" field above, the horizontal blue line indicates the elapsed time since the alarm setpoint was exceeded. In this example, the generator reverse power setpoint is -5%. If the commissioning is done without the PC utility software, the timers can be seen in the service menu 9120.

8. Adjustment

8.1 Adjustment overview

8.1.1 Overview

The adjustment of the unit can be carried out when the initial settings of the governor and the AVR are made.

The controller of the unit is a PID controller.

The unit includes different controllers which must be tuned in at the correct running situations (see the table below):

Controller	Purpose	Tune in conditions
Frequency controller	Controls the frequency when the Multi-line 2 is in island mode (stand-alone).	Tune in when the generator is running with the generator breaker open.
Power controller	Controls the power when the Multi-line 2 is running with fixed power/base load.	Tune in when the generator is running parallel to the mains.
P load share controller	Controls the power when the Multi-line 2 is running in load sharing mode.	Tune in when the generator is running in load sharing mode.
Voltage controller	Controls the voltage when the Multi-line 2 is in island mode (stand-alone).	Tune in when the generator is running with the generator breaker open.
Reactive power controller	Controls the VAr when the Multi-line 2 is running with fixed VAr load.	Tune in when the generator is running parallel to the mains or in load sharing mode.
Q load share controller	Controls the reactive power when the Multi-line 2 is running in load sharing mode.	Tune in when the generator is running in reactive load sharing mode.

8.2 Adjusting PID controller

8.2.1 PID controller

Before the PID controllers of the Multi-line 2 are tuned in, the values of the K_p , T_i and T_d of all controllers must be decreased to a low value.

Start by tuning in the K_p factor, and then tune in the T_d and T_i . Normally, the controllers are tuned in following a few general rules as given below.

8.2.2 Step 1, adjustment of the K_p

Only the P regulator is to be active (T_d and T_i set to 0 s), and the operation of the genset must be stable. Now increase the K_p factor step by step, until the genset becomes unstable. Adjust the K_p factor to 50% of the value found above.

8.2.3 Step 2, adjustment of the T_i



With the K_p setting set to the value found in step 1, raise the T_i to a high value, e.g. 30 s, and decrease T_i step by step, until the genset becomes unstable. Adjust the T_i to approx. 1.5-1.7 times the value where instability begins.

8.2.4 Step 3, adjustment of the T_d

Step by step increase the T_d until the genset becomes unstable. Adjust the T_d to 50...70% of the value.

8.2.5 Step 4, readjustment of controller settings

It can be necessary to make a readjustment of the controller settings, if during testing the genset turns out to be unstable to some extent. If this is the case, then adjust the K_p , T_d and T_i until the operation is satisfactory.

-  **The T_i and T_d settings are only available when analogue controller output is used.**
-  **To see the effect of the new adjustments when tuning in the Multi-line 2, remember to make a regulation deviation, e.g. by applying a load jump.**

8.2.6 Manual governor and AVR control

In many cases, it is difficult to tune in the controller using load jumps (no load bank available). When this is the situation, the manual control can be used as an easy way to make regulation deviations during the commissioning.

This function can be activated by pressing  more than 2 seconds, or by activating the digital inputs or AOP buttons for governor or AVR control in semi-auto mode. The intention of this function is to give the commissioning engineer a helpful tool for adjustment of the regulation.

The function of the regulation window depends on the selected mode:



G	0	0	0V
f-U Setp	100%	100%	
f-U Setp	50%	50%	
	<u>GOV</u>		AVR



8.2.7 Manual mode/switchboard control

In manual mode or switchboard control, the regulation is deactivated. When activating the up or down arrows, the output value to GOV or AVR is changed, this is the Reg. value in the display. The up and down arrows have the same function as the digital inputs or AOP buttons for governor and AVR control when the window is open. To exit the regulation window, press "back".

-  **GPC/GPU/GPU Hydro/PPU: Manual GOV/AVR control inputs are not active in SWBD control.**

8.2.8 Semi-auto mode (AGC 200/AGC-3/AGC-4 only)

As in manual mode, the  and  arrows have the same function as the digital inputs or AOP buttons for governor or AVR control when the window is open.

The value "setp" can be changed by pressing the arrow  or . When GOV is underlined, the governor setpoint will be changed, and vice versa when the AVR is underlined. When changing the setp value, an offset will be added to or subtracted from the nominal value. The reg. value is the output value from the regula-

tor. If the genset is running in parallel, the active or reactive nominal power setpoint value will be changed. If it is a stand-alone genset not parallel to the mains, the nominal frequency or voltage setpoint will be changed and also displayed. When the "back" button is activated, the regulation setpoint returns to nominal.

i If the digital inputs or AOP buttons are activated in semi-auto, the regulation window is automatically opened.

8.2.9 Auto and test mode (AGC 200/AGC-3/AGC-4 only)

Similar to semi-auto except from the fact that activating the digital inputs or AOP buttons for governor or AVR control will change the regulation setpoint but not open the regulation window. When the digital inputs or AOP buttons are deactivated, the regulation setpoint returns to nominal.

i PPM: Test mode is only available for an emergency generator.

i AVR setpoint manipulation requires option D1.

i Regarding AOP setup, please refer to "Help" in the PC utility software.

8.3 Relay output adjustments

8.3.1 Relay output adjustments

If the relay outputs are used for the speed governor/AVR, it will be necessary to adjust the relay minimum pulse time and the period time.

There are two settings: ON time, which is the shortest relay ON signal time.
PER time, which is the period time.

The shortest acceptable pulse time is depending on the reaction of the governor/AVR and connection type. Slow reaction requires a long time pulse.

As a starting point, use the following settings for the relay ON time and relay period time:

Governor ON time	Menu 2601	500...1000 ms	
Governor period time	Menu 2602	2500...5000 ms	It is recommended that the period time is approximately 5xON time.
AVR ON time	Menu 2721	100 ms	
AVR period time	Menu 2722	500 ms	It is recommended that the period time is approximately 5xON time.

i It is still necessary to tune in the P controllers.

8.4 Resulting speed/voltage curve upon load change

8.4.1 Resulting speed/voltage curve upon load change

Testing is easily done by using (if possible) a load bank applying "jumps" in the generator load, hereby testing the speed/voltage control.

The optimum result is indicated by this curve:

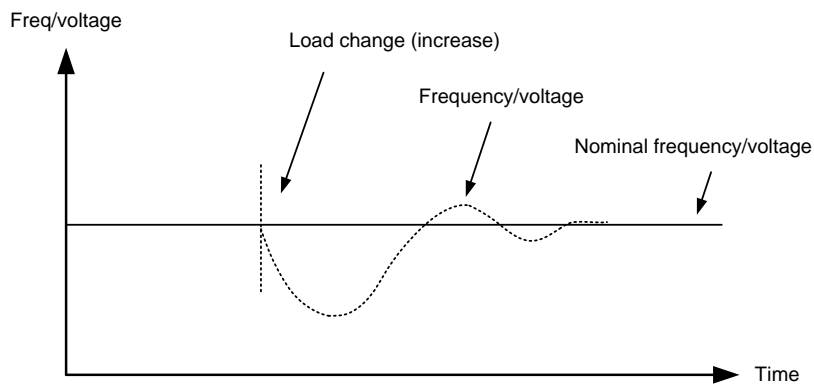

As indicated, 2-3 "overshoots" before stabilising after a sudden change is OK. If more "overshoots" are present, decrease the K_p factor and try again.

9. Troubleshooting

9.1 Troubleshooting for Multi-line 2 and Uni-line products

9.1.1 Remedy of problem

The troubleshooting table can be used for the Uni-line and the Multi-line 2 products.

Problem indication	Problem cause	Remedy
Load sharing or fixed power control (base load) unstable. Synchronisation OK. Single generator running frequency control OK.	No speed droop on generators.	Apply 3-4% speed drop on prime mover governor.
Load sharing or fixed power voltage (VAr) control unstable. Synchronisation OK. Single generator running frequency control OK.	No voltage droop on generators.	Apply 3-4% voltage drop on generator AVR.
Generator not able to take load to 100%.	Initial setting of speed governor not correct.	See chapters regarding governor/AVR checks.
Generator not able to take load to 100%.	Analogue output from DE-IF equipment has too low output range.	Increase the full scale value. This is mostly a case when using electronic potentiometers.
Speed decreases when increase was expected (relay outputs).	Relay outputs "up" and "down" reversed.	Swap connections.
Speed decreases when increase was expected (analogue output).	Outputs "+" and "-" reversed.	Swap connections.
Engine overspeeds when starting up.	Regulator output is too high.	Decrease the analogue output signal by decreasing the resistor.