



-power in control



Datasheet



Pitch Motor PMSM SP190D8

- Permanent Magnet
- Compact and light weight
- High peak torque
- Excellent efficiency
- Maintenance free, No fan
- 5 year warranty



DEIF A/S · Frisenborgvej 33 · DK-7800 Skive
Tel.: +45 9614 9614 · Fax: +45 9614 9615
info@deif.com · www.deif.com

Document no.: 4121260008a

1 Application

The Pitch motor is a perfect choice for this specific application. The motor is based on state of the art technology for Permanent Magnet Synchronous Motors, PMSM. The motor has no external fan or additional components; therefore the robustness is high meaning low maintenance.

This motor is primary for on shore applications, it can also be ordered by special request as a low temperature and/or off shore model.

The high peak torque capability makes the PMSM unique for pitch applications, which make the motor size smaller than other motor types.

The motor have a built electro static and fail safe brake. The brake is supplied with 24 V, having a total energy consumption of 160 W.

The motor is also equipped with a high precision resolver for closed loop control system and high accuracy positioning.

The build in KTY and PT100 sensors are used for the monitoring of the motor state.

2 Characteristics

- Compact motor with the smallest design of all motor types usable for the pitch system.
- Rear Earth magnets on the rotor.
- Build in 24 V brake
- Built in pt100 in the rotor windings.
- Built in KTY in rotor winding.
- IP65 complete motor
- Easy snap motor cables.

3 Technical information

3.1 Data

			Note
Ke(pk)	V	110, 120, 180	At 1000 rpm
Peak torque	Nm	107	
Stall torque	Nm	33	
Number of poles		8	4 pole pairs
Operation		S1	
Insulation		Class F	

3.2 Motor ratings

Field weakening can be applied to the motor, in order to achieve higher speeds at low terminal voltage.

Motor types			110 V	130 V	180 V	Note
Operation speed	Power	Torque	Current	Current	Current	
[RPM]	[kW]	[Nm]	[Arms]	[Arms]	[Arms]	
1000	2,9	27,6	21,7	18,4	13,2	50°C max ambient
1500	4,0	25,5	20,3	17,0	12,3	
2000	5,0	23,9	18,2	15,6	11,4	
Max speed	RPM @300Vdc		2700	2300	2300	50°C max ambient
Max speed	RPM @560Vdc		5000	4000	4000	
Kt	[Nm/A]		1,28	1,53	2,10	
Peak current	[Arms] 3 sec.		103	89	63	
Resistance	[Ω]		0,22	0,30	0,61	
Inductance	[mH]		3,6	5,0	9,7	

3.3 Derating

Derating of the motor power and nominal motor torque as a function of height above sea level and ambient temperature. Peak torque is not derated.

Above sea level	Ambient temperature (°C)						
	< 30	30-40	45	50	55	60	65
0	1.12	1.08	1.04	1.00	0.95	0.88	0.80
1000	1.07	1.00	0.96	0.92	0.87	0.82	0.77
1500	1.04	0.97	0.93	0.89	0.84	0.79	0.74
2000	1.00	0.94	0.90	0.86	0.82	0.77	0.72
2500	0.96	0.90	0.86	0.83	0.78	0.74	0.69
3000	0.92	0.86	0.82	0.79	0.75	0.70	0.66

3.4 General

Environment		Note
Temperatures	Operating: -20...50 °C, free natural convection Storage: -40...55 °C	IEC 60068-2-1 IEC 60068-2-2 IEC 60255-1
Humidity	97% condensation at +55 °C	IEC 60068-2-30, test Db IEC 60255-1
Altitude	3000 m over sea-level, reduced maximum temperature according IEC standard, including derating.	
Bearing system	Bearing system lubricated with grease for total life time 30,000 hours.	
Rotor balance level	G1.0	
EMC/CE	Immunity	IEC 61000-6-2 IEC 60255-26
	Emission	IEC 61000-6-4 IEC 60255-26
Vibration	3...13.2 Hz: 6 mmpeak-peak 13.2...50 Hz: 2.1 g 3...13.2 Hz: 2 mmpeak-peak 13.2...100 Hz: 0.7 g	IEC 60068-2-6, DNV C IEC 60068-2-6, DNV A IEC 60255-21-1
Bump	25 g, 6 ms, half sine. Tested with 1000 bumps in each direction in all 3 axes. A total of 6000 bumps per test.	IEC 60068-2-27, test Ea IEC 60255-21-2
Safety and protection		
Protection	IP 65, Class I	IEC/EN 60529
Safety	Installation category III, 600 V, pollution degree 2	EN 61010-1 IEC 60255-27 IEC 60255-1 IEC EN 60950
Lightning protection	Class 2	IEC 61400-24CDV
Electrical equipment of machines.	IEC 60204-1	

3.5 Sensors and Brake

Resolver Data			Note
Number of poles		2	
Transformation ratio		0,5 ± 10%	
Accuracy		±6' or ±0,10°	
Input current		58 mA	7V, 5 kHz
Phase shift		8° ±3°	7V, 5 kHz
Brake			
Voltage	V DC	24	
Power consumption	W	33	± 7% at 20°C
Holding Torque	Nm	100	Spring applied
Temperature			
Thermistor		PTC / Philips KTY84-130	
PT100		2 wire	

3.6 Physical ID

Environment		Note
Case	Cast aluminum, painted mat black.	
Shaft	Nitrile seal	
Weight	33,5 kg	With feedback device & brake
Inertia	0,0133 kgm ²	With feedback device & brake
Dimensions	Flanch: Outer diameter: 300 mm or square. Spigot diameter: 180 mm Body (WxHxD): 190x190x426 mm Including speed sensor.	More details se the section: "Mechanical outline". All values for IEC 112 and IEC 132.
Maintenance	None	
Mounting	4 pcs. Ø14 mm holes for screw or bolt mounting on 215 mm diameter.	
Shaft dimensions	IEC 132: Diameter: 38 mm Length: 80 mm Keyway (WxHxD) 8x10x70 mm	More details se the section: "Mechanical outline".
	IEC 112: Diameter: 28 mm Length: 60 mm Keyway (WxHxD) 7x 8x50 mm	
Terminals	M40 M23	Power feedback

4 Performance curve

Curves for 300V & 560VDC

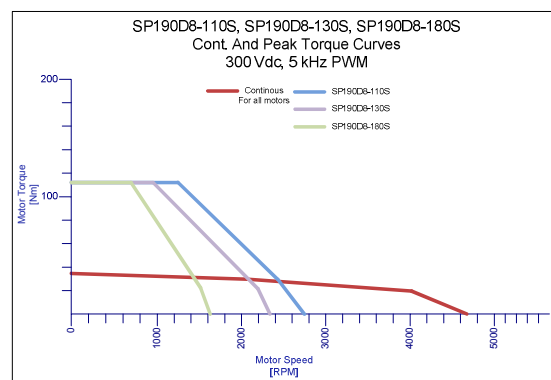
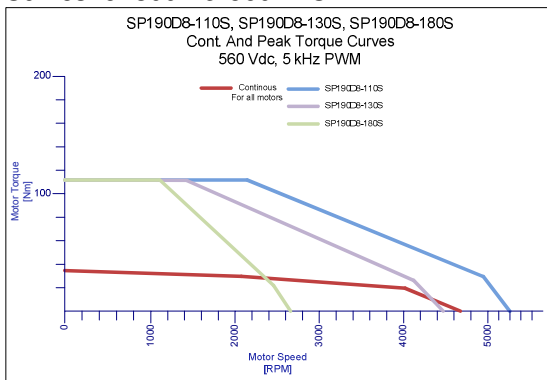

5 Mechanical outline

IEC132 round flange.

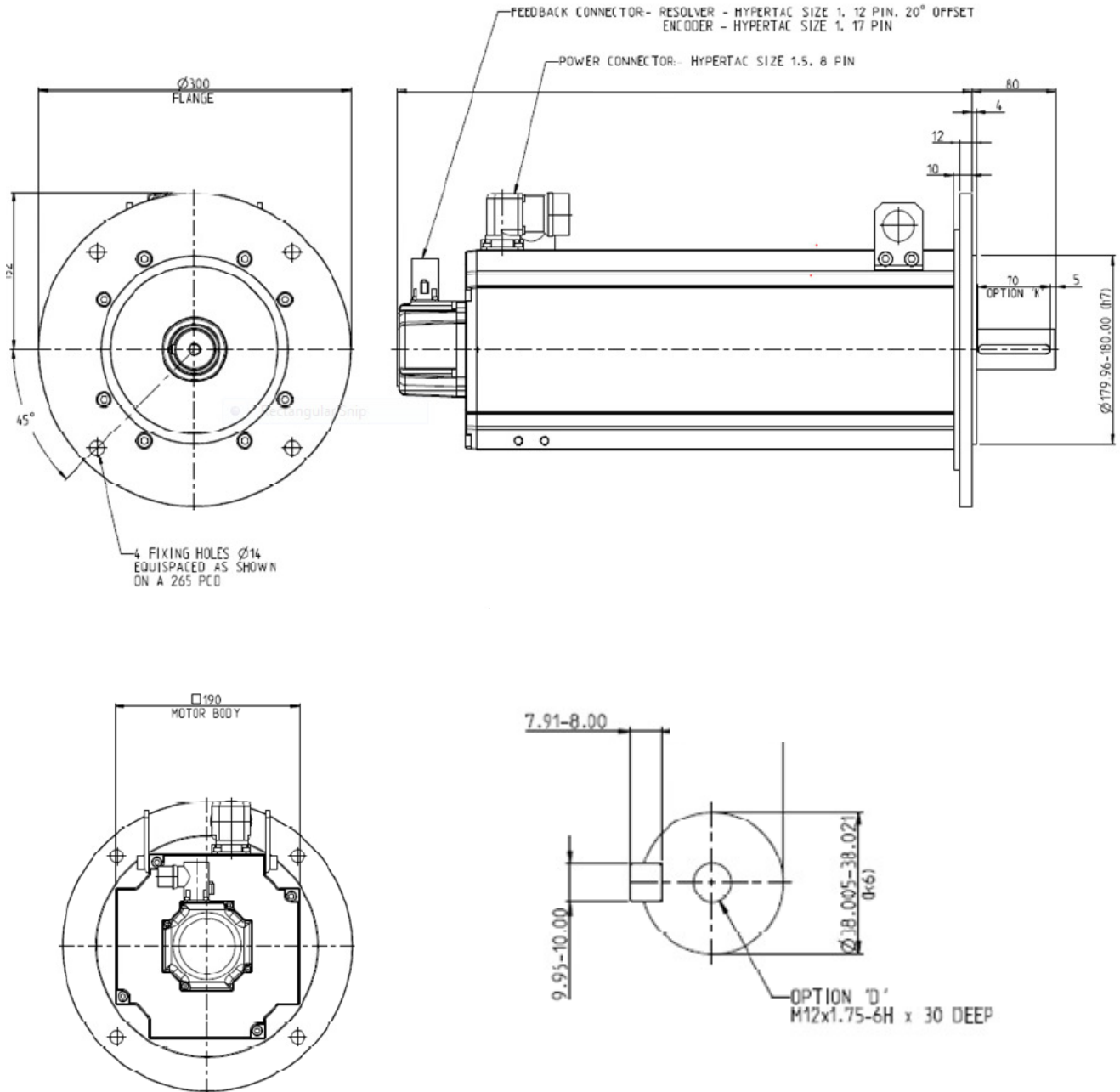

All dimensions are in mm.

6 Electrical termination

Standard size 1.5 (M40)
8 pin power connector,
Hypertac.

Standard size 1.0 (M23)
12 pin feedback connector,
Hypertac.

PIN	FUNCTION
U	MOTOR U
V	MOTOR V
1	HEATER HE1 (IF FITTED) ORANGE
2	HEATER HE2 (IF FITTED) ORANGE
+	BRAKE B1+ (IF FITTED)
-	BRAKE B2- (IF FITTED)
W	MOTOR W
⊥	MOTOR EARTH ⊥

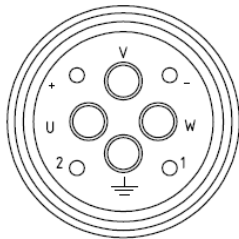

INTERCONNECTRON
SIZE 1.5 8 PIN

PIN	FUNCTION	WIRE COLOUR
1	STATOR 2nd PHASE S2	YELLOW
2	STATOR 2nd PHASE S4	BLUE
3	SECOND THERMAL SENSOR 2K1+ (IF FITTED)	BROWN OR RED
4	SECOND THERMAL SENSOR 2K2- (IF FITTED)	WHITE
5		
6		
7	ROTOR R2	*
8	FIRST THERMAL SENSOR 1K1+	BROWN
9	FIRST THERMAL SENSOR 1K2-	WHITE
10	ROTOR R1	RED/WHITE
11	STATOR 1st PHASE S1	RED
12	STATOR 1st PHASE S3	BLACK

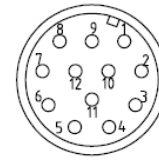

INTERCONNECTRON
SIZE 1 12 PIN (20° OFFSET)

* IF LITTON RESOLVER FITTED R2 IS BLK/WHT

7 Motor and feedback cable

The motor and resolver cable for this motor can also be ordered as separate components.

7.1 Motor cable

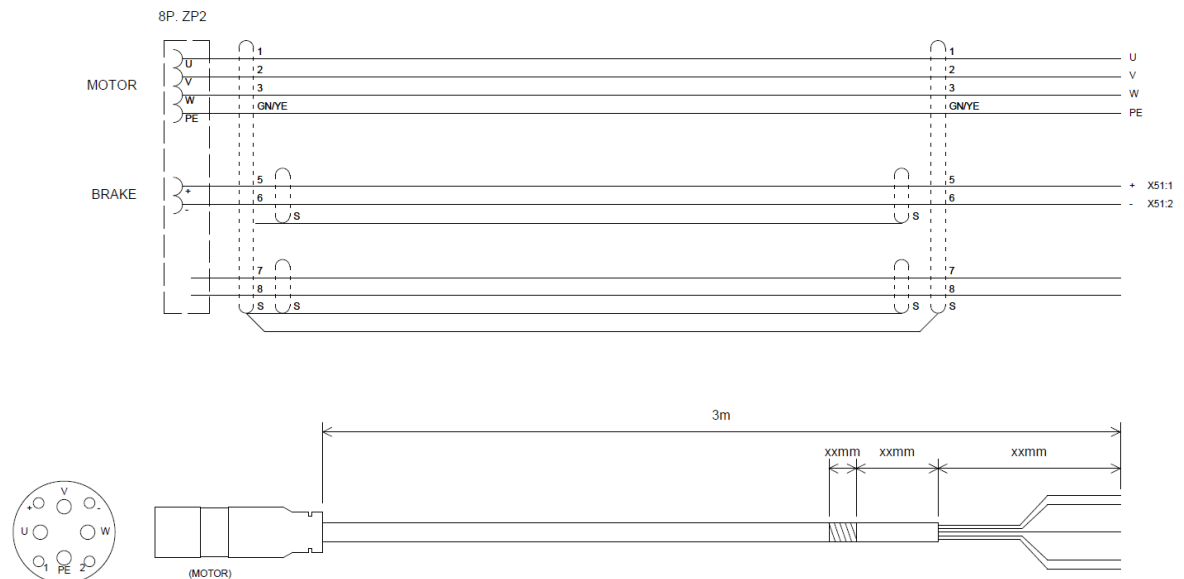

7.2 Feedback cable

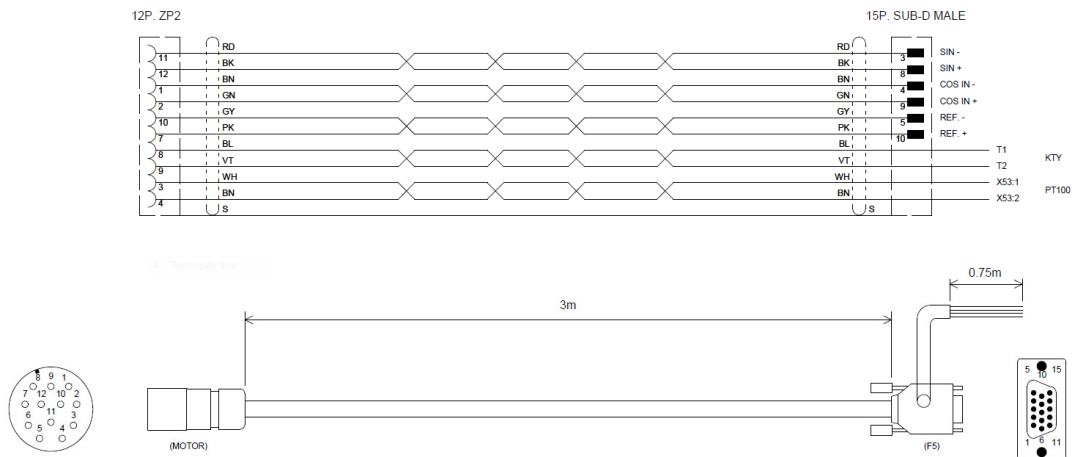

8 Ordering information

PMSM-SP190D8-110S

DEIF no. 1031410008

PMSM-SP190D8-130S

DEIF no. 1031410002

PMSM-SP190D8-180S

DEIF no. 1031410009

Motor Cable, standard plug Size 1.5

DEIF no. 1031490001

Feedback cable Standard Size 1.0

DEIF no. 1031490005

DEIF A/S reserves the right to change any of the contents of this document without prior notice.